

**CAL/OSHA**

**POCKET GUIDE FOR  
THE CONSTRUCTION  
INDUSTRY**

**2022**



[www.dir.ca.gov](http://www.dir.ca.gov)

## Table of Contents

|   |    |
|---|----|
| About This Pocket Guide . . . . .                             | 5  |
| Workplace Safety and Health . . . . .                         | 5  |
| Access . . . . .  | 6  |
| Administrative Requirements. . . . .                          | 7  |
| Aerial Devices and Elevating Work Platform Equipment. . . . . | 12 |
| Airborne Contaminants and Dust . . . . .                      | 13 |
| Air Compressors . . . . .                                     | 14 |
| Asbestos . . . . .  | 14 |
| Blasting (Abrasives/Sand) . . . . .                           | 19 |
| Blasting (Explosives) . . . . .                               | 19 |
| Carcinogens . . . . .   | 21 |
| Code of Safe Practices. . . . .                               | 21 |
| Competent Person . . . . .                                    | 22 |
| Concrete Construction . . . . .                               | 22 |
| Confined Spaces . . . . .                                     | 27 |
| Corrosive Liquids. . . . .                                    | 31 |
| Cranes . . . . .  | 31 |
| Demolition . . . . .  | 40 |
| Dust, Fumes, Mists, Vapors, and Gases . . . . .               | 42 |
| Electrical . . . . .  | 43 |
| Elevators, Lifts, and Hoists . . . . .                        | 48 |
| Emergency Medical Services . . . . .                          | 49 |
| Engine Exhaust Emission . . . . .                             | 50 |
| Erection and Construction . . . . .                           | 51 |
| Ergonomics in Construction . . . . .                          | 54 |
| Excavation, Trenches, and Earthwork. . . . .                  | 56 |
| Explosion Hazards . . . . .                                   | 65 |
| Fall Protection . . . . .                                     | 66 |
| Fire Protection and Prevention. . . . .                       | 71 |

## This Guide...

does not provide full legal interpretation of Cal/OSHA regulations or their underlying statutes.

Readers should refer directly to Cal/OSHA title 8 regulations in the California Code of Regulations ([www.dir.ca.gov/samples/search/query.htm](http://www.dir.ca.gov/samples/search/query.htm)) and to the California Labor Code (<http://leginfo.legislature.ca.gov/faces/codes.xhtml>) for detailed information regarding the scope, specifications, and exceptions of a particular regulation and for other requirements that may be applicable to their operations.

### Publications Unit—Updated July 2022

Produced by the California Department of Industrial Relations (DIR), Division of Occupational Safety and Health (Cal/OSHA).

Copyright © 2022 State of California, Department of Industrial Relations. Permission granted to display, perform, reproduce and distribute exclusively for nonprofit and educational purposes, and may not be used for any commercial purpose. All other rights reserved.

To obtain copies of Cal/OSHA safety and health publications, contact a Cal/OSHA Consultation Services office listed in the back of this booklet, or go to [www.dir.ca.gov/dosh/puborder.asp](http://www.dir.ca.gov/dosh/puborder.asp).

|  |     |   |     |
|--|-----|---|-----|
| First Aid . . . . .                              | 72  | Toilets/Washing Facilities/Sanitation . . . . . | 141 |
| Flaggers . . . . .                               | 72  | Tools and Equipment . . . . .                   | 142 |
| Flammable and Combustible Liquids . . . . .      | 73  | Traffic Control . . . . .                       | 149 |
| Forklifts . . . . .                              | 74  | Training . . . . .                              | 150 |
| Forms, Falsework, and Vertical Shoring . . . . . | 77  | Tunnels and Tunneling . . . . .                 | 151 |
| Guardrails . . . . .                             | 78  | Welding, Cutting, and Other Hot Work . . . . .  | 154 |
| Hazard Communication Program (HAZCOM) . . . . .  | 81  | Wildfire Smoke . . . . .                        | 157 |
| Heat Illness Prevention . . . . .                | 83  | Wood Preservative Chemicals . . . . .           | 158 |
| Heavy Construction Equipment . . . . .           | 90  | Work Over or Near Water . . . . .               | 158 |
| Hot Pipes and Hot Surfaces . . . . .             | 93  | List of Acronyms . . . . .                      | 160 |
| Housekeeping/Site Cleaning . . . . .             | 94  | Index . . . . .                                 | 163 |
| Injury and Illness Prevention Program . . . . .  | 94  |   |     |
| Ladders . . . . .                                | 96  |   |     |
| Laser Equipment . . . . .                        | 102 |   |     |
| Lead . . . . .                                   | 103 |   |     |
| Lighting . . . . .                               | 106 |   |     |
| Lock-out/Block-out Procedures . . . . .          | 107 |   |     |
| Machine Guarding . . . . .                       | 110 |   |     |
| Multi-Employer Worksites . . . . .               | 110 |   |     |
| Personal Protective Equipment . . . . .          | 111 |   |     |
| Pile Driving . . . . .                           | 113 |   |     |
| Pressurized Worksites . . . . .                  | 115 |   |     |
| Qualified Person . . . . .                       | 116 |   |     |
| Ramps and Runways . . . . .                      | 117 |   |     |
| Roofing Operations . . . . .                     | 117 |   |     |
| Scaffolds . . . . .                              | 122 |   |     |
| Silica Dust . . . . .                            | 137 |   |     |
| Stairways . . . . .                              | 138 |   |     |
| Temporary Agencies . . . . .                     | 139 |   |     |
| Toeboards . . . . .                              | 140 |   |     |

## About This Pocket Guide

The construction industry involves many types of work activities covered by numerous regulations in title 8 of the California Code of Regulations (T8 CCR). T8 CCR contains detailed information on regulations and workplace safety programs, including specifications and exceptions. Construction employers may have requirements in the Construction Safety Orders (CSOs), Electrical Safety Orders (ESOs), Tunnel Safety Orders (TSOs), Compressed Air Safety Orders (CASOs), and the General Industry Safety Orders (GISOs).

To assist the construction industry in working safely and complying with title 8 regulations, the Cal/OSHA Publications Unit has updated this Pocket Guide. This guide is intended to be used as a reference for workers, employers, supervisors, job stewards, safety personnel, and others. This Pocket Guide:

- Summarizes safety requirements from T8 CCR that apply to the construction industry. It is not meant to be either a substitute for or a legal interpretation of the occupational safety and health regulations in T8 CCR (see T8 CCR for detailed information).
- Lists the major subject headings in alphabetical order in the Table of Contents, and each subject heading is linked to its content.
- Provides highlights of selected safety standards in each major subject heading within its scope and may also include best practices in safety and health.
- Is not all-inclusive. The contents under the bullets, lists, notes, and exceptions are highlights of regulatory requirements, best practices, and other construction safety and health information. Readers should refer directly to T8 CCR for complete information.
- Contains abbreviations as described in the List of Acronyms section. It is available in PDF format and can be printed online.

## Workplace Safety and Health

Proactive safety and health programs are an effective way to prevent workplace injuries and illnesses and reduce the costs of doing business. In such programs, employers and employees work together to ensure that safety and health are always part of the decisions made and all employees and supervisors are fully

trained to work safely. The benefits of effective, proactive safety programs include

- higher productivity and employee morale,
- higher quality of work and products produced,
- fewer worker injuries,
- lower compensation insurance cost and absenteeism, and
- lower employee turnover.

A written Injury and Illness Prevention Program (IIPP) should be the foundation for all of your other safety and health programs and is required for every workplace regulated under T8 CCR. A summary of the basic elements of an IIPP has been included in the Injury and Illness Prevention Program section of this guide. Employers are also encouraged to use Cal/OSHA's IIPP resources ([www.dir.ca.gov/dosh/PubOrder.asp#IIPP](http://www.dir.ca.gov/dosh/PubOrder.asp#IIPP)) to develop a specific IIPP tailored to their own workplaces.

Remember, the effectiveness of all your safety programs depend on how well you actually implement and maintain them. You must regularly review and update your programs in order to keep them effective. Employers and employees must also remember that the regulations in T8 CCR only set minimum requirements and they should strive to exceed the standards at all times.

**For safety- and health-related assistance, employers and employees may contact the nearest Cal/OSHA Consultation Office listed on the back cover of this guide.**

## Access

The employer must provide safe access to and from all work levels or surfaces. Regulated means of access are as follows:

- A. Stairways, ramps, or ladders must be provided at all points where a break in elevation of 18 inches or more occurs in a frequently traveled passageway, entry, or exit. **1629(a)(3)**
- B. Aerial devices, such as cherry pickers and boom trucks, may be vehicle-mounted or self-propelled and used to position employees, tools, and materials. **3637**, and **3648**
- C. Elevating work platforms, such as vertical towers and scissor lifts, are designed to raise and hold a work platform in a substantially vertical axis. **3637**, and **3642**
- D. Industrial trucks, such as rough terrain forklifts, may be used to elevate and position workers under specific conditions. **3657**

E. Elevators (construction) are required as follows:

1. For structures or buildings 60 ft. or more above ground level or 48 ft. below ground level. **1630(a)**
2. At demolition sites of seven or more stories or 72 ft. or more in height. **1735(r)**

*Note: Elevators must be inspected and tested in the presence of a DOSH representative before use. A permit from DOSH is required before operating. **1604.29(a)***

F. Personnel hoists may be used at special construction sites, such as bridges and dams, if approved by a registered engineer. **1604.1(c)**

G. Ladders can be used to gain access to working surfaces above and below ground level under certain conditions. **1675**

H. Ramps and runways provide means of access for foot or vehicle traffic. **1623**, **1624**, and **1625**

I. Stairways must be installed in buildings that have two or more stories or are 24 ft. or more in height. **1629(a)(1)**

1. For buildings of two or three stories, at least one stairway is required. **1629(a)(4)**
2. For buildings of more than three stories, two or more stairways are required. **1629(a)(4)**

J. The following routes of access are prohibited:

1. Endless belt-type manlifts. **1604.1(a)(3)**
2. Single-cleat ladders more than 30 ft. or double-cleat ladders more than 24 ft. long. **1629(c)**
3. Cleats nailed to studs. **1629(b)**
4. Rides on loads, hooks, slings, or concrete buckets of derricks, hoists, or cranes. **1718(a)**, and **1720(c)(3)**

## Administrative Requirements

Employers must meet certain administrative requirements that may include Cal/OSHA notification, specific registration, permitting, certification, recordkeeping, and the posting of information in the workplace. Some of these requirements depend on the construction trade or type of activity in which employers are involved. The more common requirements are listed below:

A. Documents required at the job site include the following:

1. Injury and Illness Prevention Program: Program document may be kept in the office. **1509(a)**, and **3203(a)**
  2. Code of Safe Practices. **1509(b)**
  3. All Cal/OSHA-required permits. **341**
  4. All Cal/OSHA-required certifications. Various
  5. Respiratory Protection Program for all work sites where respirators are mandatory. **5144(c)**
  6. Heat illness prevention. **3395**
  7. Fall protection plan, if required. **1671.1**
- B. Postings required at the job site include the following:
1. Cal/OSHA poster "Safety and Health Protection on the Job." **340**
  2. Code of Safe Practices. **1509(b)**, and (c)
  3. Emergency phone numbers. **1512(e)**
  4. Employee access to records notification to inform employees that they have the right to gain access to medical and exposure records. **3204(g)**
  5. Operating permit for air tanks. **461(a)**
  6. Operating rules for industrial trucks and tow tractors (if used), where employees operate forklifts. **3664**, and **3650(c)**
  7. Authorized access at controlled access zones (CAZs). **1671.1**, and **1671.2**
  8. Variance process. **411.3**
  9. Cal/OSHA registration. **341.4**, and **341.10**
  10. Citations. **332.4**
  11. Hazard warning signs at the following job sites:
    - a. Where asbestos work is being done. **341.10**, and **1529(k)**
    - b. Where lead work is being done. **1532.1(m)**
    - c. At confined spaces. **Article 37**, **5158**
    - d. At controlled access zones. **1671.2**
    - e. On cranes, concrete pumps, high-lift trucks, etc., (high-voltage warning signs). **2947**, Group 13
    - f. On powder-actuated tools. **1691(n)**
    - g. On lasers (laser levels, etc.). **1801(d)**
    - h. On air compressors with an automatic-start function. **3320**
- C. Recordkeeping requirements are included in T8 CCR for the purpose of establishing a historical record of compliance. These requirements include the following:
1. Cal/OSHA Log 300.  
*Note: You can download a package of forms and instructions for Log 300 recordkeeping from the Cal/OSHA Publications webpage at [www.dir.ca.gov/dosh/dosh\\_publications/RecKeepOverview.pdf](http://www.dir.ca.gov/dosh/dosh_publications/RecKeepOverview.pdf).*
  2. Lock-out/block-out activity records. **3314**
  3. Operation and maintenance activity records. **1509**, and **3203**
  4. Medical surveillance program and records.
  5. Training records.
  6. Inspection records.
- D. Reports and notifications to Cal/OSHA must be made of the following incidents and activities:
1. Serious injury or illness, or death. A report must be made immediately by telephone (within 8 hours) to a district office. Employers are allowed 24 hours if they can show that circumstances prevented the report from being made within 8 hours. **342(a)**  
*Note: A serious injury or illness is defined as one that requires inpatient hospitalization for other than medical observation or diagnostic testing, or when an employee suffers an amputation, the loss of an eye, or any serious degree of permanent disfigurement. **330(h)***
  2. Blasting accidents or unusual occurrences. A report must be forwarded to the district office within 24 hours. **5248(a)**
  3. Construction activities annual permit. Employers governed by an annual permit must notify DOSH before starting the work. **341.1(f)**
  4. Asbestos-related work. The DOSH district office must be notified 24 hours before starting work that is subject to registration. **341.9(a)**

5. Use of regulated carcinogens. The employer must report operations involving the use of a regulated carcinogen within 15 days. **5203**
  6. Construction involving lead-work. Written notification must be made to the DOSH district office 24 hours before starting work. **1532.1(p)**
- E. Employers should promptly notify affected employees of the monitoring results of ANY required monitoring for regulated substances. Such notifications must be made within the required time frame. Some common substances requiring notification include:
1. Asbestos, methylenedianiline, cadmium, chromium (VI), and lead: Notify within 5 working days following receipt of monitoring results. **1529(f)(5)(A)**, **1535(f)(7)(A)**, **1532(d)(5)(A)**, **1532.2(d)(4)(A)**, **1532.1(d)(8)(A)**
  2. Vinyl chloride: Notify within 15 working days following receipt of monitoring results. **5190(d)(4)(A)**, **5210(d)(6)**
  3. Formaldehyde: Notify within 15 days following receipt of monitoring results. **5217(d)(6)**
- F. Project or Annual permits issued by Cal/OSHA are required for various construction activities. **341**

A Project Permit is required for: **341(d)**

- Use of diesel engines in any mine or tunnel.
- Demolition or dismantling of a structure more than 36 ft. high. **341(d)(3)**
- Erecting/raising/lowering or dismantling a fixed tower crane.

An Annual Permit is required for employers when the structure is over 36 ft. high and employers are engaged in the following activities: **341(d)(4)**

- Erection and placement of structural steel or structural members other than steel.
- Installation of curtain walls/precast panels or fascia.
- Installation of metal or other decking.
- Forming or placement of concrete structures/decks on steel structures.
- Installation of structural framing (including roof framing) or panelized roof systems.

Annual or Project Permit is needed for:

- Construction of trenches or excavations 5 ft. or deeper into which a person is required to enter.
- Erection and placement of scaffolding, vertical shoring, or falsework more than 36 ft. high.

Operating permit is required for:

- Operating specified air compressors. **461**
- Operating tower cranes if the employer is subject to **341**, **341.1**, and **344.70**.

*Note: Most permits can be obtained from a DOSH district office. A safety conference and a review of the employer's safety program will be scheduled before permit issuance. **341.1(c)***

*Exception: Permit requirements do not apply to certain activities. See **341(e)**.*

G. Certification requirements are necessary in the following circumstances:

1. Power operated cranes and derricks exceeding 3 tons rated capacity shall not be used in lifting service until the equipment has been certified by a DOSH licensed certifier. **1610.9**
2. Operators of mobile and tower cranes must have a valid certificate. See exceptions. **1618.1**
3. Asbestos consultants and site surveillance technicians must be certified by DOSH. **341.15**
4. Training certification is required for many activities and trades (see specific Safety Orders). **title 8**

H. Registration and licensing are required in the following circumstances:

1. Asbestos registration. An employer must register with DOSH when engaged in asbestos-related work on 100 sq. ft. or more of surface area. **341.6**
2. Blaster's License. The blaster must be a licensed blaster or directed by a licensed blaster and be at least 21 years of age. **5238**

# Aerial Devices and Elevating Work Platform Equipment

A. Aerial devices, such as cherry pickers and boom trucks, may be vehicle-mounted or self-propelled and used to position employees. **3637**

General safety requirements are as follows: **3648**

1. Only authorized persons may operate aerial devices. **3648(c)**
2. Aerial devices must not rest on any structure. **3648(a)**
3. Controls must be tested before use. **3648(b)**
4. Workers must stand only on the floor of the basket. No planks, ladders, or other means are allowed to gain greater heights. **3648(e)**
5. A fall protection system must be worn and attached to the boom or basket. **3648(o)**
6. Brakes must be set when employees are elevated. **3648(g)**
7. An aerial lift truck must not be moved when an employee is on the elevated boom platform except under conditions listed in **3648(l)**.

B. Elevating work platform equipment, such as vertical tower, scissor lift, and mast-climbing work platform, may be used to position employees and materials **3642**.

General safety requirements are as follows: **3642**

1. The platform deck shall be equipped with a guardrail or other structure around its upper periphery. Where the guardrail is less than 39 inches high, a personal fall protection system is required. **3642(a)**
  2. The platform shall have toeboards at sides and ends. **3642(f)(1)**
  3. No employee shall ride, nor tools, materials, or equipment be allowed on a traveling elevated platform. See exceptions. **3646**
  4. Units shall not be loaded in excess of the design working load. **3646(f)**
- C. The following information must be displayed on the device: **3638(c)**

1. Manufacturer's name, model, and serial number.
2. Rated capacity at the maximum platform height and maximum platform travel height.
3. Operating instructions.
4. Cautions and restrictions.

D. Devices must be designed to applicable American National Standards Institute (ANSI) standards. **3638(b)**

*Note: See clearances for operations near high-voltage conductors in the Electrical section of this guide.*

## Airborne Contaminants and Dust

The employer must control employees' exposures to airborne contaminants and employees' skin contact with those substances identified in Table AC-1 of **5155** and **1528**. Airborne contaminants suspended in the air can exist in different forms, including gases, vapors, and particulates (particles of either liquids or solids). Table AC-1 contains the Permissible Exposure Limits (PELs) for these substances. The PEL applies to the sum of the exposures to the substance in the vapor state and from the particulate fraction. **5155**

Some of the substances listed in **Table AC-1** also have specific performance standards, noted in the CSOs and the GISOs, for controlling employee exposure. These substances include asbestos (**1529**); cadmium (**1532**); lead (**1532.1**); benzene (5218); methylenedianiline (**1535**); beryllium (**1535.1**); concrete and masonry materials (**1530.1**); chromium (VI) (**1532.2**); respirable crystalline silica (**1532.3**); carbon monoxide (**5155**); internal combustion engines (**1533**); vinyl chloride (**5210**); and welding fumes (**1536, 1537**).

Airborne contaminants must be controlled by: **5141**

- Applying engineering controls.
- Removing employees from exposure to the hazard and by limiting the daily exposure of employees to the hazard.
- Providing respiratory protective equipment whenever such engineering controls are not practical or fail to achieve full compliance.

*Note: Check **Table AC-1** frequently as the content is regularly updated; and employers must display the required warning signs in work areas where hazardous contaminants and dust are present.*



# Air Compressors

General requirements for air compressors include:

- A. Employers must obtain a DOSH permit for the air tanks of air compressors operated at a work site. **461(a)**  
*Exception: No permit is required for tanks equipped with a safety valve set to open at no more than 15 psi pressure, or tanks having a volume of 1 1/2 cu. ft. or less with a safety valve set to open at no more than 150 psi. 461(f)*
- B. Warning signs are required for electric air compressors equipped with an automatic-start function. **3320**
- C. Safety valves must be popped weekly. **1696(d)**
- D. Air tanks must be drained per manufacturer's recommendation. **1696(c)**
- E. Fans shall be guarded with a shroud or side screens. **1696(b)**
- F. Portable air compressors on wheels must be prevented from rolling. **1696(a)**

# Asbestos

The word "asbestos" refers to six naturally occurring, fibrous, hydrated mineral silicates that differ in chemical composition.

They are actinolite, amosite, anthophyllite, chrysotile, crocidolite, and tremolite. Nonfibrous forms of the last three minerals listed here are regulated by GISO **5208.1**. You may encounter asbestos at a construction site in the following applications and areas:

- Excavations where asbestos-bearing rock outcroppings are at or near the surface.
- Fireproofing for steel-frame high-rise buildings.
- Pipe and boiler insulation.
- Insulators of electrical conductors.
- Plaster, cement, drywall, and taping compounds.
- Floor tile and tile adhesives.
- Acoustical ceilings (tiles and sprayed on).
- Asbestos-cement piping, shingles, and panels.

- Roofing felt and sealing compounds.

Because asbestos exposure has been linked to serious illnesses, Fed/OSHA and Cal/OSHA have implemented strict regulations to minimize exposures to work site and "take-home" asbestos. Below is a summary of regulatory requirements:

- A. Construction projects are subject to regulation under **1529** if they involve one or more of the following activities, regardless of the percentage of asbestos present:
  1. Demolition or salvage of structures where asbestos is present.
  2. Removal or encapsulation (including painting) of materials that contain asbestos.
  3. Construction, alteration, repair, maintenance, or renovation of structures, substrates, or portions thereof that contain asbestos.
  4. Installation of products that contain asbestos.
  5. Erection of new and the improvement, alteration, and conversion of existing electric transmission and distribution lines and equipment.
  6. Excavation that may involve exposure to naturally occurring asbestos, excluding asbestos mining and milling activities.
  7. Routine facility maintenance.
  8. Transportation, disposal, storage, and containment of and site housekeeping activities involving asbestos or materials containing asbestos.
  9. Asbestos spills and emergency cleanups.

Regulatory requirements for work activities subject to **1529** vary depending on the percent, amount, or type of asbestos-containing materials involved. Listed below are selected requirements and the activities to which they apply:

- B. Cal/OSHA administrative requirements are as follows:
  1. Registration and district office notification if disturbing 100 sq. ft. or more of manufactured construction materials containing more than 1/10 of 1% of asbestos-containing construction material (ACCM). **341.6(a)**
  2. Carcinogen notification with exposures in excess of permissible exposure limits (PELs).
  3. The employer shall notify affected employees of the

- monitoring results of asbestos within 5 working days following receipt of monitoring results. **1529(f)(5)(A)**
4. DOSH certification is required for all persons performing duties of an asbestos consultant or technician. **341.15(a)**
  5. “Asbestos consultant” means any person who contracts to provide professional health and safety services relating to asbestos. **1529(q)(1)**
- C. Training is required for all employees engaged in Class I through IV work and all work in which they are likely to be exposed in excess of the PELs. The training must be provided:
1. At the employer’s expense.
  2. Before or at the time of initial assignment.
  3. Annually after initial training.
  4. In accordance with **1529(k)(9)**.
- D. Permissible exposure limits (PELs): The employer must ensure that employee exposures do not exceed: **1529(c)**
1. Eight-hour time-weighted average of 0.1 fibers/cc.
  2. Thirty-minute excursion limit of 1 fiber/cc. **1529(c)**
- E. Multi-employer work sites are regulated under **1529**:
1. The general contractor on the project must exercise general supervisory authority. **1529(d)**
  2. An employer performing work that involves asbestos must notify other employers at the site. **1529(d)**
  3. All employers on site must ensure that their own employees are not exposed to asbestos fibers due to a breach in containment or control methods used by the creating employer. **1529(d)**
- F. Exposure assessments and monitoring are required as follows:
1. Initial exposure assessment must be made by all employers subject to **1529** before or at the onset of the project. **1529(f)(2)**
  2. Daily exposure monitoring of employees must be conducted by all employers disturbing materials that contain more than 1% asbestos in Class I and II work. **1529(f)(3)**
3. All employers must monitor daily representative exposure of employees performing Class I and II work.
 

*Exceptions **1529(f)(3)**:*

*No monitoring required when:*

    - » *The employer has made a negative exposure assessment for the entire operation.*
    - » *Employees are equipped with supplied-air respirators (SARs) operated in the pressure demand mode, or other positive pressure mode respirator. However, employees performing Class I work using certain control methods shall be monitored daily even if they are equipped with SARs.*
  4. Periodic exposure monitoring of employees must be conducted when disturbing asbestos-containing materials (ACMs) in operations involving other than Class I and II work during which the PELs might be exceeded. **1529(f)(3)**
- G. Respirator protection requirements are specific to asbestos-related activities and exposures, as outlined in **1529(h)**:
1. The employer must provide appropriate respirators to employees; however, employers shall not use filtering facepiece respirators for protection against asbestos fibers. **1529(h)(3)**
  2. The appropriate respirator must be selected from Table 1 of **5144(d)(3)(A)(1)** and **1529(h)**.
  3. The employer must provide HEPA filters for powered and non-powered air-purifying respirators. **1529(h)(3)(B)**
  4. A written respiratory protection program must be implemented in accordance with **5144(c)**, **1529(h)(2)**.
- H. Methods of compliance and work practices are noted below:
1. A wet method must be used unless the employer can demonstrate that it is not feasible. **1529(g)(1)**
  2. Vacuum cleaners with high-efficiency particulate air (HEPA) filters must be used to clean up ACM and presumed asbestos-containing material (PACM). **1529(g)(1)**
  3. Prompt cleanup and disposal in labeled leak-tight containers are required except as specified in **1529(g)(8)(B)**, **1529(g)(1)**.

4. Specific work practices for different activities are also outlined in **1529, 1529(g) (4-11)**
  5. Stripping of finishes shall be conducted using low abrasion pads at speeds lower than 300 rpm and wet methods. **1529(g)**
- I. Prohibited work practices and controls are as follows:
1. Spraying of any substance containing any amount of asbestos (see exception). **1528**
  2. High-speed abrasive disc saw cutting of ACM or PACM without appropriate point of cut ventilator or enclosures with HEPA-filtered exhaust air. **1529(g)(3)**
  3. Using compressed air to remove asbestos or materials containing asbestos. **1529(g)(3)**
  4. Dry sweeping, shoveling, or other dry cleaning of dust or ACM or PACM debris. **1529(g)(3)**
  5. Rotating employees as a means of reducing exposure to asbestos. **1529(g)(3)**
- J. Employer needs to include asbestos in the HAZCOM program **5194**, regardless of employee airborne exposure levels, and make sure that: **1529**
1. Employees have access to labels (on containers of asbestos) and safety data sheets.
  2. Employees are trained as per **5194** and **1529. 1529(k)(1)(B)**.
  3. Warning signs shown below are displayed at each regulated area as per **1529(k)(7)**:
 

**DANGER**

**ASBESTOS**

**MAY CAUSE CANCER**

**CAUSES DAMAGE TO LUNGS**

**AUTHORIZED PERSONNEL ONLY**
  4. Labels on containers for protective clothing and equipment, scrap, waste, and debris with asbestos fibers show the following information as per **1529(k)(8)(C)**:
 

**DANGER**

**CONTAINS ASBESTOS FIBERS**

**MAY CAUSE CANCER**

**CAUSES DAMAGE TO LUNGS**

**DO NOT BREATHE DUST**

**AVOID CREATING DUST**

## Blasting (Abrasives/Sand)

Regulations for blasting with abrasives and sand include the following:

- A. Employees must wear supplied-air respirators (covering the head, neck, and shoulders) during abrasive blasting:
  1. When dust may exceed limits specified in **5155, 5151(b)(1)(B)**.
  2. With silica sand or where toxic material evolves. **5151(b)(1)(C)**

*Note: A dust filter respirator may be used for 2 hours during abrasive blasting if the concentration of silica dust is less than ten times the limit specified in **5151(b)(1)(C)**.*
- B. Hearing protection must be worn as required by **1521**.
- C. Body protection must be worn as required by **1522**.

## Blasting (Explosives)

A person must hold a valid California Blaster's License and must be physically present when performing, directing, and supervising blasting operations. No person under the age of 21 years shall be permitted in any explosive magazine or be permitted to use, handle, or transport explosives. **5238(a), 5276(g)**

*Exception: Persons 18 years or older and under the direct personal supervision of a licensed blaster.*

- A. Blaster's License requirements are discussed in **344.20**.
- B. All blasting accidents affecting worker safety must be reported to DOSH within 24 hours. **5248(a)**

*Note: Accidents involving a serious injury or illness must be reported to DOSH immediately but not longer than 8 hours. **342(a)***

- C. Explosives must be stored in the proper type of magazine (see [5252](#) Table EX-1), [5251\(a\)](#)
- D. Caps and detonators must be stored in separate magazines away from other explosives. [5251\(b\)](#), (c)
- E. Storage requirements are discussed in [5251](#), [5252](#), and [5253](#).
- F. Transportation requirements are discussed in Subchapter 7 [Article 115](#) (Index). [5270](#)
- G. Safety rules for blasting operations are as follows:
  - 1. No smoking or open flames are permitted within 50 ft. of explosives handling. [5276\(a\)](#)
  - 2. No source of ignition, except during firing, is permitted in areas containing loaded holes. [5276\(a\)](#)
  - 3. Only non-sparking tools are to be used for opening containers of explosives. [5276\(b\)](#)
  - 4. Explosives must be kept clear of electrical circuits by 25 ft. [5276\(d\)](#)
  - 5. Unused explosives must be returned promptly to the magazine. [5276\(e\)](#)
  - 6. Blasting mats must be used when flying material could damage property. [5276\(f\)](#)
  - 7. A tally sheet that records all movement of explosives must be kept at each magazine. [5251\(n\)](#)
  - 8. Holes may be loaded only after all drilling is complete. (see exception in [5278\(a\)](#), [5278\(a\)](#))
  - 9. No vehicle traffic should pass over loaded holes. [5278\(c\)](#)
  - 10. Loaded holes must be attended. [5278\(o\)](#)
  - 11. Workers must not try to quench an explosive's fire. [5276\(l\)](#)
  - 12. Explosives at a blast site must be attended. [5278\(o\)](#)
  - 13. No one but the attendant(s), the loading/detonation crew, inspection personnel, and authorized supervisory personnel shall be allowed within 50 ft. of the loaded holes. [5278\(o\)\(3\)](#), (w)(3)
  - 14. Blasts shall not be fired without the licensed blaster in-charge verifying the conditions listed in [5291\(b\)](#), and without a warning signal/procedure. The signals shall be heard clearly in areas that could possibly be affected by the blast. [5291\(b\)](#)

## Carcinogens

Whenever carcinogenic (cancer-causing) chemicals, as specified in the GISOs [Article 110 Regulated Carcinogens](#) are present in construction materials, the employer must comply with the reporting requirements and safety rules. [5203](#)

- A. For all regulated carcinogens that specify a requirement for the employer to establish a regulated area, use of a regulated carcinogen within such a regulated area shall be reported to Cal/OSHA. For regulated carcinogens that do not have a regulated area requirement, use of the regulated carcinogen shall be reported in certain circumstances. [5203\(c\)](#)
- B. Initial use/changes in reported information of a regulated carcinogen shall be reported in writing to Cal/OSHA within 15 days. [5203\(d\)](#)
- C. Employers with temporary worksites need to provide the initial use/changes report for their permanent workplace location. [5203\(e\)](#)
- D. A copy of the applicable written report of use, temporary worksite notification, and emergency report shall be posted for affected employees to see. [5203\(g\)](#)
- E. In case of an emergency: [5203\(f\)](#)
  - A report of the occurrence of an emergency and the facts obtainable at that time shall be made to Cal/OSHA within 24 hours.
  - A written report shall be filed within 15 days.

The safety data sheet (SDS) and labels on the container must be reviewed to determine the presence of carcinogens.

## Code of Safe Practices

The Code of Safe Practices is a set of worksite rules that stipulate how to perform job duties safely and to keep the work site safe. The following are selected requirements:

- A. The employer must develop and adopt a written Code of SafePractices. [1509\(b\)](#)

*Note: Plate A-3 in Appendix A of 1938 is a suggested code. The code is general and should be used as a starting point for developing a code that fits the contractor's operations.*

- B. It must be specific to the employer's operations. **1509(b)**
- C. It must be posted at each job site office or be readily available at the job site. **1509(c)**
- D. Workers, when first hired, shall be given instructions regarding the hazards and safety precautions and directed to read the Code of Safe Practices. **1510(a)**
- E. Supervisors shall conduct "toolbox" or "tailgate" safety meetings, or the equivalent, with their crews at least every 10 working days to emphasize safety.

## Competent Person

A competent person is defined in **1504(a)** as one who is capable of identifying existing and predictable hazards in the surroundings or working conditions that are unsanitary or dangerous to employees. The competent person has authority to impose prompt corrective measures to eliminate these hazards.

Some SOs identify specific requirements for the competent person's training, knowledge, abilities, and duties. The following is a list of CSOs that require the use of a competent person: asbestos **1529(o)**; (2) excavation **1541, 1541.1**; (3) cadmium **1532(b)**; (4) fall protection **1670, 1671.2**; (5) bolting and riveting **1716**; (6) pressurized worksites **6075**; (7) lift-slab construction operations **1722.1(i)**; (8) permit-required confined spaces **1952(a)**; and (9) silica **1532.3(g)(4)**.

## Concrete Construction

Injuries and illnesses common to the concrete construction industry are as follows:

- Burns, rashes, and skin irritations from exposure to cement dust or wet concrete.
- Silicosis, a respiratory disease caused by inhaling silica dust from exposure to concrete dust during such operations as concrete cutting, drilling, grinding, or sandblasting.
- Broken bones, lacerations, and crushing injuries caused by falls from elevated work surfaces; impalement by rebar or other objects; and impact from falling objects, form and shoring failure, and structural failure of components of the project.

Because the hazards associated with concrete construction are great, employees must use appropriate personal protective equipment and conform to safe work practices at all times (see below).

### A. Placement of Concrete. **1720**

1. Concrete pumping equipment and placing booms shall be set-up and operated according to manufacturer's guidelines and the title 8 safety orders.
2. The manufacturer's operation manual shall be maintained in legible condition and available at the job site.
3. Controls in the equipment shall have their function clearly marked.
4. Operation of concrete placing booms in proximity of overhead high-voltage lines shall be in accordance with **Article 37** of the High-Voltage Electrical Safety Orders.
5. Equipment shall be inspected by a qualified operator prior to daily use and the inspection must be documented.

### B. Forms/falsework and vertical shoring in the Forms, Falsework, and Vertical Shoring section of this guide. **1717**

### C. Masonry construction. **1722**

1. All masonry walls more than 8 ft. high must be braced to prevent overturning and collapse unless the wall is adequately supported through its design or construction method. The bracing shall remain in place until permanent supporting elements of the structure are in place. **1722(b)**
2. A limited access zone (LAZ) shall be established whenever a masonry wall is being constructed and must conform to the following:
  - a. The LAZ shall be established before the start of construction. **1722(a)(1)**
  - b. The LAZ shall be established on the side that does not have scaffolding. **1722(a)(2)**
  - c. The width of the LAZ shall be equal to the height of the wall to be constructed plus 4 ft. and shall run the entire length of the wall. **1722(a)(3)**
  - d. The LAZ shall be entered only by employees actively engaged in constructing the wall. No other employee shall be permitted entry. **1722(a)(4)**
  - e. The LAZ shall remain in place until the wall is

adequately supported to prevent collapse unless the height of the wall is more than 8 ft., in which case the LAZ shall remain in place until the requirements of **1722(b)** have been met. **1722(a)(5)**

### Illustration 1 | Troughs

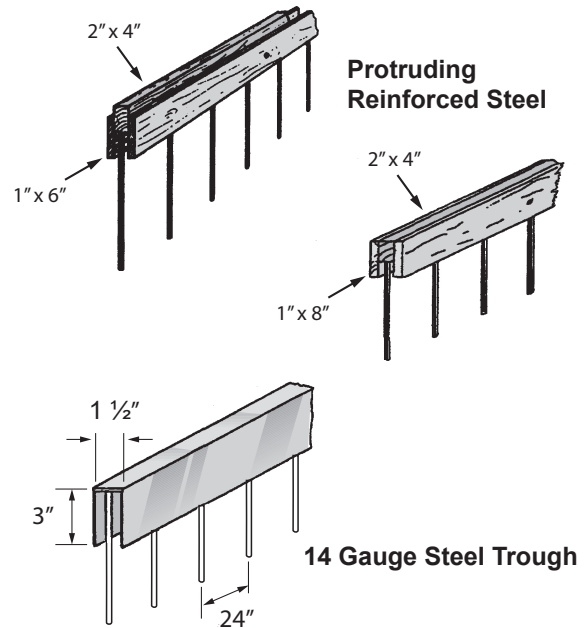

#### D. Precast, prefabricated concrete construction, tilt-up, panels. **1715**

1. An erection plan, addenda, and procedure shall be prepared by or under the direction of a Professional Engineer registered in California.
2. The erection plan, addenda, and procedure shall be available at the job site.
3. Job site inspections shall be made by the responsible engineer (or representative) during the course of erection.
4. Proposed field modifications shall be approved by the responsible engineer.

#### E. Rebar and other impalement hazards. **1711** and **1712**

1. Employees working at grade or at the same surface level as exposed protruding rebar or similar projections shall be protected against impalement by guarding exposed ends that extend up to 6 feet above grade or other work surface, with approved protective covers or troughs (see Illustrations 1 and 2). **1712(c)** and **(d)**
2. Employees working above grade or above any surface and who are exposed to protruding rebar or similar projections shall be protected from impalement by:
  - a. The use of guardrails, or
  - b. Approved fall protection systems, or
  - c. Approved troughs and covers per **344.90**, **1712(c)** and **(d)**.
3. Job-built wood protective covers and troughs shall be built of at least “standard grade” Douglas Fir.
4. Manufactured protective covers shall be approved by Cal/OSHA in accordance with **344.90**.
5. Personal fall protection (or equivalent) must be used while employees place or tie reinforcing steel in walls, columns, piers, and other structures more than 6 ft. high. **1711(i)**

*Exception: Reinforcing ironworkers may travel point-to-point horizontally or vertically on reinforcing steel up to 24 ft. above the surface below if there are no impalement hazards.*

Troughs can be used for impalement protection if the following apply:

- The trough designs shown above can be used when employees are working at heights of 6 ft. or less “above grade.”
- If employees are working at heights above 6 ft., the design must be specified by an engineer (Ca PE).
- Job-built wood troughs must be constructed of at least “standard grade” Douglas Fir.

## Illustration 2 | Protective Covers

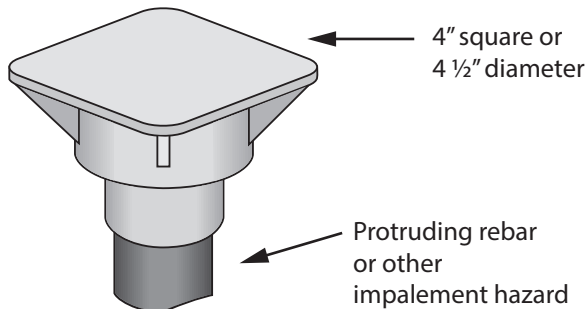

Manufactured protective covers used for impalement protection must meet the following requirements:

- The protective covers must be Cal/OSHA-approved.
- The cover surface must be at least 4 in. square. If the cover is round, its surface must have a minimum diameter of 4 1/2 inches. For a trough, the protective cover must be at least 4 inches wide.
- The protective covers used "above grade" must be designed to withstand the impact of a 250-lb. weight dropped from 10 ft.
- The protective covers used "at grade" must be designed to withstand the impact of a 250-lb. weight dropped from 7 1/2 ft.

## Mushroomed Cap

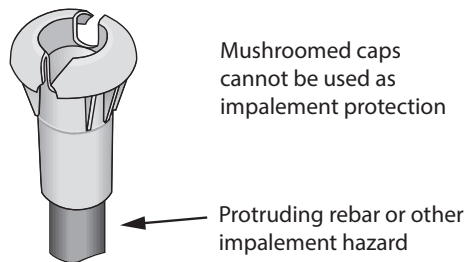

6. Guying and supporting of all rebar for walls, piers, columns, and similar vertical structures are required.
7. Wire mesh rolls shall be secured to prevent dangerous recoiling action. **1711**

### F. Concrete finishing

1. Powered finishing tools must be equipped with a dead-man-type control.
2. Bull float handles must be constructed of a nonconductive material if they could come into contact with energized electrical conductors.

## Confined Spaces

Every year several confined space entrants and would-be rescuers die from hazards, such as oxygen deficiency, toxic and explosive atmospheres, engulfment, and uncontrolled energized equipment. To prevent such accidents, employers must be able to:

- Recognize confined spaces and which of them are permit-required confined spaces.
- Know, understand, and effectively implement T8 CCR **Article 37** (1950-1962) and **5158** requirements. Section 5158 contains certain requirements not found in **Article 37**.

- A. A confined space is defined in **1951** as a space that exhibits the following characteristics:
  1. Is large enough and so configured that an employee can bodily enter it.
  2. Has limited or restricted means for entry and exit.
  3. Is not designed for continuous employee occupancy.
- B. The following are examples of some of the locations that may exhibit confined-space conditions. **1950(a)**:
  1. Pits (such as elevator, escalator, pump, valve, or other equipment)
  2. Manholes (such as sewer, storm drain, electrical, communication, or other utility)
  3. Tanks (such as fuel; chemical; water; or other liquid, solid, or gas)
  4. Concrete pier columns

5. Sewers
  6. Storm drains
  7. Enclosed beams
  8. Vessels
  9. Cesspools
  10. Turbines
- C. A permit-required confined space is defined in **1951** as a confined space that also has one or more of the following characteristics:
1. Contains or has a potential to contain a hazardous atmosphere.
  2. Contains a material that has the potential for engulfing an entrant.
  3. Has an internal configuration such that an entrant could be trapped or asphyxiated by inwardly converging walls or by a floor that slopes downward and tapers to a smaller cross-section.
  4. Contains any other recognized serious safety or health hazard.
- D. Before starting work at a worksite, the employer must have a competent person identify all confined spaces and permit-required confined spaces in which the employer's employees might work. **1952(a)**
- E. Exposed employees at the worksite must be informed of any permit spaces by posting danger signs or by any other equally effective means. Employees' authorized representatives and the controlling contractor must also be informed—by other than posting—of the existence, location, and danger posed by each permit space. **1952(b)**
- F. Whenever possible, employees should avoid entering these spaces or use equipment that allows work to be done from the outside. If employees must enter:
1. The employer must comply with the applicable Cal/OSHA regulations in T8 CCR. These include:
    - Section **1509** (Injury and Illness Prevention Program)
    - **Article 6** (Excavations)
    - **Article 37** (Confined Spaces in Construction) of the Construction Safety Orders

- **Section 5158** (Other Confined Space Operations)
  - Sections **2943(b)** and **2943.1** (High Voltage Electrical Orders—Enclosed Spaces)
2. All affected employers are required to have a written permit space program that complies with section **1953**. In general, the employer must have:
- Procedures to identify and evaluate all permit-required confined spaces before employees enter them.
  - Measures to prevent unauthorized entry into permit spaces.
  - A system for preparing, issuing, using, and canceling entry permits.
  - Procedures to test and monitor the permit spaces before and during all employee entries.
  - Procedures to have an attendant outside the permit space at all times while employees are working inside.
  - Effective controls of all existing and potential atmospheric and/or physical hazards inside the permit space.
  - Appropriate equipment (testing and monitoring tools, ventilation, PPE, lighting, rescue tools, etc.).
  - Employee and supervisor training on safe work procedures, hazard identification and controls, and rescue procedures.
  - Effective rescue and emergency procedures that are immediately available on site.
  - Procedures to coordinate entry operations when employees of more than one employer enter the permit space.

Note:

- (1) This is just a partial list of the requirements of a permit space program.
- (2) Refer to section **1952** for details on when permit-required confined spaces can be “reclassified” as non-permit, or permit-required confined spaces can be entered via “alternate procedures.”
- (3) Refer to section **1950** for details on the scope and application of **Article 37**, including the following exceptions:



- a. Construction work regulated by Construction Safety Orders, **Article 6**, Excavations. However, a confined space created within an excavation (e.g., a pipe or other structure) may constitute a permit-required confined space covered by **Article 37** requirements.
  - b. Construction work regulated by the Tunnel Safety Orders. However, a confined space created within a tunnel (e.g., a pipe or other structure) may constitute a permit-required confined space covered by **Article 37** requirements.
  - c. Construction work regulated by General Industry Safety Orders, **Group 26**, Diving Operations.
  - d. Construction work regulated by the General Industry Safety Orders, **Article 154**, Pressurized Worksite Operations.
- (4) **Section 5157** describes permit-required confined space requirements for non-construction operations.

**Illustration 3 | Retrieval Equipment in Use**



## Corrosive Liquids

Employers must provide the following when employees handle corrosives:

- Personal protective equipment. **1514(a)**
- Safety data sheets (SDS) in English. **5194(g)**
- Properly labeled containers with appropriate hazard warnings. **5194(f)**

*Note: Employers who become newly aware of any significant information regarding the hazards of a chemical shall revise the labels for the chemical within six months of becoming aware of the new information. **5194(f)(11)***

- An eyewash and a deluge shower that meet ANSI standards. **3400(d)**, **5162**

*Note: Emergency eyewash facilities and deluge showers shall be in accessible locations that require no more than 10 seconds for the injured person to reach.*

- A written hazard communication (HAZCOM) program. **5194(e)**

## Cranes

Hazards that are associated with crane operations include electrocution from overhead power lines and equipment failures because of operator error; faulty or damaged equipment; overloading; support failure such as ground or outrigger collapse; and miscommunication.

All of the regulations for cranes used in construction are covered in T8 CCR sections **1610–1619**, **1694**, **2940**, and **6060**. **1610–1619** covers Cranes and Derricks in Construction, **1694** covers Side Boom Cranes, **2940** covers Mechanical Equipment, and **6060** covers Procedures During Dive. For requirements/details on cranes and derricks in construction, refer to the above sections.

To maintain safe and healthful working conditions, employers and employees must ensure that:

1. All requirements, including prohibitions, are met.
2. Manufacturer's instructions are followed.
3. All crane operators have a valid certificate of competency

- for the specific type of crane that they are operating.
4. Necessary tools, protective equipment, and trainings are provided.
  5. Employees comply with all requirements of crane operation and perform tasks safely at all times.

Below is a summary of the regulatory requirements for cranes and derricks used in construction:

- A. General requirements for cranes and derricks are given in sections **1610.1–1610.9**. Requirements include:
1. Scope applies to power operated equipment when used in construction that can hoist, lower and horizontally move a suspended load. **1610.1**
  2. Design requirements are given in **1610.2** and **4884**.
  3. Definitions as per **1610.3**.
  4. Design, construction, and testing of cranes and derricks with over 2,000 lbs. of hoisting/lifting capacity must meet requirements in **1610.4**.
  5. Ground conditions, including slope, compaction, and firmness, and all supporting materials, such as blocking, mats, cribbing, marsh buggies, etc., must meet the requirements in **1610.5**.
  6. Equipment modifications or additions that affect the capacity or safe operation of the equipment are prohibited except where the requirements of subsections as shown in **1610.6** are met.
  7. Fall protection is critical in crane operations and must be provided by employers. The fall protection system varies depending on the type of crane being used and the work activity. Requirements for fall protection are given in **1610.7**.
  8. For cranes with a rated hoisting/lifting capacity of 2,000 lbs. or less, the employer must ensure that all of the requirements in **1610.8** are met.
  9. For cranes with a rated hoisting/lifting capacity over 3,000 lbs., the employer must ensure that the cranes, derricks, and accessory gears are not used until there is a verification of current certification as per **1610.9**.
  10. A copy of the current certification must be available with each crane and derrick or at the project site. **1610.9(a)**

11. Proof load tests and examinations of cranes and their accessory gear must be conducted as per **5022, 1610.4(f)**.
  12. Do not operate cranes with wheels or tracks off the ground or working surface at any time unless properly bearing on outriggers or stabilizers. **4994(a)**
- B. Sections **1611.1** through **1611.5** address all of the safety requirements related to assembly and disassembly operations.
1. When assembling or disassembling equipment (or attachments), the employer must comply with all applicable manufacturer prohibitions and requirements in **1611.1**.
  2. The general requirements for assembly and disassembly operations, including supervision, review of procedures, crew instructions, etc., are given in **1611.2**.
  3. Employers/operators must also follow the requirements for dismantling booms and jibs as specified in **1611.3**.
  4. Employer procedures for assembly/disassembly shall be developed by a qualified person. **1611.4**
  5. The employer shall follow the power line safety (up to 350 kV) requirements of **1611.5**. Employers and employees always need to presume that power lines are energized.
- C. Power line safety is regulated under T8 CCR subsections **1612.1** through **1612.4**. The requirements vary depending on the voltage of the power line. The following requirements apply:
1. For equipment operations with potential involvement of power lines up to 350 kV, the employer shall follow the power line safety requirements of T8 CCR **1612.1**.
  2. For power lines over 350 kV, the employer shall follow all of the requirements of **1611.5** and **1612.1**. See exceptions.
  3. For all energized power lines (all voltages), whenever equipment operations, including load lines or loads, are closer than the minimum approach distance under Table A, the employer shall prohibit these operations. **1612.3**
  4. Unless the overhead high-voltage power lines are de-energized and visibly grounded, the operation, erection, or handling of tools, machinery, apparatus, supplies, or materials, or any part thereof over the power lines is prohibited. **1612.3(b)**
  5. If equipment travels under or near power lines with no

load, the employer must establish procedures and criteria, and follow the safety requirements of T8CCR **1612.4**.

- D. Requirements for inspections and repairs of cranes and derricks are given in T8 CCR sections **1613.1** to **1613.12**. Specific requirements include the following:
1. Prior to initial use, all equipment that has modifications or additions that affect the safe operation of the equipment or capacity shall be inspected by a certifying agency. The inspection shall meet the requirements of T8 CCR **1613.1**.
  2. Inspections of repaired/adjusted equipment are subject to the requirements in **1613.2**.
  3. Post-assembly inspections are subject to the requirements in **1613.3**.
  4. The inspections conducted on each shift are subject to the requirements in **1613.4**.
  5. Periodic inspections shall be conducted at least four times a year. Cranes shall not be operated more than 750 hours between periodic inspections. The inspection shall include all items as per **1613.5**.
  6. Annual/comprehensive inspections need to be done as per **1613.6**.
  7. Where there is a reasonable probability of damage or excessive wear, the employer shall stop using the equipment and a qualified person shall inspect the equipment for structural damage, which must be evaluated by the certifying agency. **1613.7**
  8. Equipment that has been idle for 3 months or more shall be inspected by a certifying agency or qualified person as per T8 CCR **1613.5** before initial use. **1613.8**
  9. General inspections must comply with **1613.9**.
  10. Inspections of wire ropes are subject to the requirements of **1613.10**.
  11. Repairs to load-sustaining members and other critical crane and derrick parts, including booms, must be performed as per the provisions of GSO. **1613.11**, **1613.12**
- E. Requirements for the selection and installation of wire ropes are given in **1614**. Selection and installation of original and replacement wire rope shall be in accordance with the

wire rope manufacturer, the equipment manufacturer, or a qualified person.

- F. Do not load slings and shackles beyond the rated capacities provided by the manufacturers. Do not use them without affixed and legible identification markings. **5042(a)**, **5049(g)**
- Requirements for the safety devices and operational aids are given in sections **1651.1** and **1615.2**:
1. Safety devices such as crane level indicator, horn, jib stops, boom stops, etc., are required on all equipment unless otherwise specified. **1615.1**
  2. Operational aids such as boom hoist limiting device, boom angle, boom length indicator, load weighing device, etc., are required on all equipment unless otherwise specified. **1615.2**
- Note: Operational aids are classified into Category I and Category II. **1615.2***
- G. Requirements for the operation of cranes and derricks include the following:
1. The employer shall:
    - a. Follow manufacturer procedures for operation of the equipment including the use of attachments. Where procedures for operation are unavailable, the employer shall comply with **1616.1**.

*Note: While operating equipment, devices such as cell phones shall not be used for any activities (texting, talking, etc.) other than signaling.*

    - b. Ensure loads are rigged by a qualified person or by a trainee under the qualified person's direct visual supervision. **1616.1(x)**
    - c. If equipment travels with a load, the employer shall ensure that a competent person supervises the operation.
    - d. Ensure operators do not suddenly accelerate or decelerate a moving load. **4999(f)**
    - e. Not allow the load, boom, or other parts of the equipment to contact any obstruction during lifting operations. **1616.1(o)**
  2. Whenever there is a concern as to safety, the operator shall have the authority to stop and refuse to handle loads until a qualified person has determined that safety has been assured. **1616.2**

3. Employers must control work areas and protect employees in the hazardous areas. Requirements include:
    - a. Communication among operators and signal persons shall be followed as per **1616.3** and **4993.1**.
    - b. Where any part of a crane or derrick is within the load radius of another crane or derrick, employers must establish a system to coordinate the operations. **1616.3**
    - c. Prevent employees from entering the hazardous areas by providing employee training, setting up barriers, etc., as per **4993.1**.
    - d. Before an employee goes to a location in the hazard area that is out of view of the operator, the employee must inform the operator. **4993.1(a)(3)(A)**.
  4. Operations shall be conducted and the job controlled in a manner that will avoid exposure of employees to the hazard of overhead loads. Wherever loads must be passed directly over workers, occupied work spaces, or occupied passageways, safety type hooks or equivalent means of preventing the loads from becoming disengaged shall be used. All requirements under **1616.4** shall also be met.
  5. Boom free fall is prohibited in each of the circumstances mentioned in **1616.5**. Controlled load lowering is required and free fall of the load line hoist is prohibited in each of the circumstances mentioned in **1616.5(d)**.
  6. The use of equipment to hoist employees is prohibited except where the employer demonstrates that the erection, use, and dismantling of conventional means of reaching the work area would be more hazardous or is not possible because of the project's structural design or worksite conditions. **1616.6(a)**
  7. Hoisting of personnel using cranes is permissible only when all of the requirements of **1616.6** are met.
- Note: The requirements of **1616.6** are supplemental and apply when one or more employees are hoisted.*
8. Supplemental requirements for using multiple crane/derrick lifts are provided in **1616.7**. Before beginning a crane/derrick operation in which multiple cranes/derricks will be supporting the load, the operation shall be planned as per **1616.7(a)** and directed by a qualified person.
- H. The general requirements for using signals during the operation of cranes and derricks are given in sections **1617.1**



to **1617.3** and include the following:

1. A signal person shall be provided in each of the situations given under **1617.1**. Only qualified persons shall be permitted to give signals except for a stop signal. Signals to operators shall be by hand, voice, or audible method and as per **1617.1**. Some of the recommended hand signals are shown in Illustration 4 on the next page.
2. The devices for transmitting signals shall be tested on site before start of operations and the devices/signaling shall meet requirements in **1617.2**.
3. Follow the additional requirements in **1617.3** for voice signals.

*Note: Employees shall not text or talk unless it is for signaling purposes.*

## Illustration 4

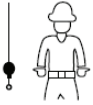
### Some of the Recommended Hand Signals

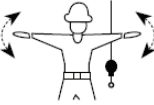
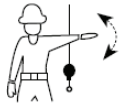
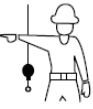
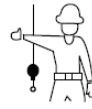
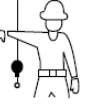
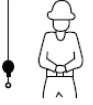
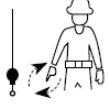
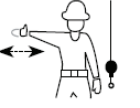
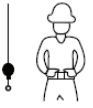
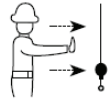
|  |   |  |
|--|---|--|
|  <p><b>Extend Telescoping Boom</b>—With hands to the front at waist level, thumbs point outward with other fingers crossed.</p>   |  <p><b>Hoist</b>—With upper arm extended to the side, forearm and index finger pointing straight up, hand and finger make small circles.</p> |  <p><b>Emergency Stop</b>—With both arms extended horizontally to the side, palms down, arms are swung back and forth.</p>                                      |
|  <p><b>Stop</b>—With arm extended to the side, palm down, arm is swung back and forth.</p>  |  <p><b>Swing</b>—With arm extended horizontally, index finger points in direction that boom is to swing.</p>                                 |  <p><b>Raise Boom</b>—With arm extended horizontally to the side, thumb points up with other fingers closed.</p>  |
|  <p><b>Lower Boom</b>—With arm extended horizontally to the side, thumb points down with other fingers closed.</p>  |  <p><b>Dog Everything</b>—Hands held together at waist level.</p>  |  <p><b>Lower</b>—With arm and index finger pointing down, hand and finger make small circles.</p>   |
|  <p><b>Raise the Boom and Lower the Load</b>—With arm extended horizontally to the side and thumb pointing up, fingers open and close while load movement is desired.</p> |  <p><b>Retract Telescoping Boom</b>—With hands to the front at waist level, thumbs point at each other with other fingers closed.</p>        |  <p><b>Travel/Tower Travel</b>—With all fingers pointing up, arm is extended horizontally out and back to make a pushing motion in the direction of travel.</p> |

*Note: For the complete list of recommended hand signals, see GISOs 5001, Plate I.*

- I. The requirements for operator qualification, training and certification, licensing, and evaluation are given in sections **1618.1** through **1618.4**. They include the following:
  1. Operator qualifications/certification/in-training/evaluation must comply with **1618.1**.
  2. Make sure that each signal person meets the qualification requirements in **1618.2** prior to giving any signals.
  3. Maintenance, inspection, and repair personnel are permitted to operate the equipment only when all of the requirements of **1618.3** are met.
  4. The employer shall provide training to all operators, signal persons, spotters, competent/qualified persons, and operators-in-training on their specific jobs as per **1618.4**.
  5. Applicant must pass a physical examination, a substance abuse test, and written and practical tests in order to obtain an operator license.
- J. T8 CCR sections **1619.1** through **1619.5** have supplemental requirements for certain types of cranes and derricks. Supplemental requirements include the following:
  1. Section **1619.1** contains supplemental requirements for erecting, climbing, operating, dismantling, and all other operations and devices used in regard to tower cranes.
  2. The supplemental requirements for derricks, whether temporarily or permanently mounted, are given in **1619.2**.
  3. Section **1619.3** contains supplemental requirements for floating cranes/derricks and land cranes/derricks on barges, pontoons, vessels, or other means of flotation. See **1619.3** for complete requirements.
  4. Overhead and gantry cranes, whether permanently or temporarily installed, are subject to the requirements of **1619.4**.
  5. The supplemental requirements for dedicated pile drivers are given in **1619.5**.
- K. Side-boom cranes mounted on wheel or crawler tractors shall meet all of the requirements of **1694(d)**.
- L. A crane/derrick used to get divers in/out of water shall not be used for any other purpose until all divers are back on board. **6060**
- M. There shall be no sudden acceleration or deceleration of the moving load.

- N. Inadvertent contact with obstructions shall be prevented. The load, boom, or other parts of the equipment shall not contact any obstruction in a way that could cause falling material or damage to the boom.

## Demolition

The primary hazards associated with demolition are:

(1) falls from elevated work surfaces; (2) exposure to hazardous air contaminants; (3) being struck by falling or collapsing structures; and (4) electrical hazards. Regulations to address these hazards include the following:

- A. A DOSH permit is required for demolition of any building or structure more than 36 ft. high. The Project Administrator shall hold a Project Permit and all other employers directly engaged in demolition or dismantling activity shall hold an Annual Permit. **341(d)(3)**
- B. A pre-demolition survey must be made to determine whether the planned work will cause:
1. Any structure to collapse. **1734(b)(1)**
  2. Worker exposure to hazardous chemicals, gases, explosives, flammable materials, or similarly dangerous substances. **1735(b)**
  3. Worker exposure to asbestos. **1529(k)(1), 1735(b)**
  4. Worker exposure to lead. **1532.1(d)(1)**
  5. Worker exposure to carcinogenic (cancer-causing) chemicals, as specified in GISOs **Article 110** Regulated Carcinogens. **5203**
  6. Worker exposure to silica. **5144**
- C. Utilities to the structure being demolished must be turned off or protected from damage. **1735(a)**
- D. Demolition techniques include the following:
1. Entrances to multi-story buildings must be protected by a sidewalk shed or a canopy. **1735(j)**
  2. Demolition work on floors and exterior walls must progress from top to bottom. **1735(f)(1)**
- Exception: Demolition with explosives and cutting chute holes are not required to progress from top to bottom. **1735(f)(1)***
3. The employer must check continually for hazards created by weakening of the structure's members. If such hazard occurs, it must be corrected before workers may continue. **1735(d)(4)**
  4. Floor openings must have curbs and stop logs to prevent equipment from running over the edge. **1735(v)**
  5. Wall openings must be guarded except on the ground floor and the floor being demolished. **1735(k)**
  6. Walkways not less than 20 inches wide must be provided as a means of access across joists, beams, or girders. **1735(h)**
  7. To prevent dust from rising, demolition debris must be wetted or other equivalent steps must be taken. **1735(t)**
  8. Whenever waste material is dropped to any point lying outside the exterior walls of the building, enclosed chutes shall be used unless the area is effectively protected by barricades, fences, or equivalent means. Signs shall be posted to warn employees of the hazards of falling debris. **1736(a)**
  9. Chutes or chute sections that are at an angle of more than 45° from the horizontal must be entirely enclosed except for openings equipped with closures at or about floor level for the insertion of materials. **1736(f)**
  10. When chutes are used to load trucks, they must be fully enclosed. Gates must be installed in each chute at or near the discharge end. A qualified person must be assigned to control the operation of the gate and the backing and loading of trucks. **1736(b)**
  11. Any chute opening into which employees dump debris by hand must be protected by a guardrail. **1736(d)**
  12. When debris is dropped through holes in a floor without the use of chutes, the area onto which the material is dropped shall be completely enclosed with barricades not less than 42 inches high and not less than 6 ft. back from the projected edge of the opening above. Signs that warn of the hazard of falling materials shall be posted at each level. Removal of debris shall not be permitted in the lower drop area until handling of debris ceases above. **1736(f)**
- E. Crane demolition work is guided by these regulations: **4941**
1. The wrecking ball's weight must not exceed 50% of the clamshell rating or 25% of the rope-breaking strength. **4941(a)**

2. The swing of the boom should be limited to 30° left or right. **4941(b)**
3. The wrecking ball must be attached with a swivel-type connection. **4941(b)**
4. The load line and ball must be inspected at least twice each shift. **4941(c)**
5. Outriggers are required when using a truck crane to swing a wrecking ball. **4941(d)**

*Note: See crane standards in the Cranes section of this guide; Group 13 in the GISOs.*

11. Harmful dust, fumes, mists, vapors, and gases from other sources.

## Electrical

Each year a large number of employees are injured or killed because they come into contact with energized electrical wiring or equipment. The Electrical Safety Orders (ESOs) are designed to control or to eliminate these often deadly exposures and include:

- A. General requirements for protection from electric shock (other than excavations). **1518**
  1. The employer must:
    - a. Identify exposed or concealed energized electric power circuits if any person, machine, or tool might come into contact with the circuit.
    - b. Advise employees of the location of energized circuits, the hazards, and protective measures.
    - c. Provide legible markings or warning signs to indicate the presence of energized electrical circuits.
  2. Protective equipment or devices must be used to protect employees if a recognized hazard exists.
  3. When protective insulating equipment is used, it shall comply with the Electrical Safety Orders.
  4. Barricades shall be used in lieu of other protective equipment.
 

*Note: 1518(d) applies to electrical installations present on job sites that do not involve excavations (as defined in 1540).*
- B. General requirements for low-voltage systems (<= 600 V)
  1. Only qualified persons may work on electrical equipment or systems. **2320.1(a)**
  2. Maintenance of electrical installations is required to ensure their safe condition. **2340.1, 2340.2**
  3. Electrical equipment and wiring must be protected from mechanical damage and environmental deterioration. **2340.26, 2340.11(a)(2), 2340.12(a)**
  4. Boxes, fittings, and enclosures must be guarded by covers or barriers to prevent accidental contact with

## Dust, Fumes, Mists, Vapors, and Gases

Oxygen-deficient atmospheres or harmful dusts, fumes, mists, vapors, or gases in concentrations sufficient to present a hazard to employees must be controlled when possible by removing the employee from the exposure, limiting daily exposure, or applying engineering controls. **1528**

- A. Whenever the above controls are not practical or fail to achieve full compliance, respiratory protection must be used in accordance with **5144, 1528(a)**
- B. Ventilation must comply with **Article 4** in the GISOs if it is used as an engineering control method. **1528(c)**
- C. Common sources of the above hazards may include:
  1. Engine exhaust emission (carbon monoxide, NO<sub>x</sub>, polycyclic aromatic hydrocarbons, and others).
  2. Blasting (CO<sub>2</sub>, NO<sub>x</sub>, asbestos, silica, dust).
  3. Concrete and rock cutting (asbestos, silica, dust).
  4. Fuel storage tanks (harmful vapors).
  5. Lead abatement (lead particles, lead compounds).
  6. Asbestos abatement (asbestos fibers).
  7. Demolition (asbestos, silica, lead, dust, etc.).
  8. Welding (fumes).
  9. Painting and spraying (solvent, vapors, lead).
  10. Sandblasting (asbestos, silica, lead, dust).

- live parts, or guarded by location if accessible only by qualified persons. **2340.17(a)**
- a. Except for fuse replacement and other necessary access by qualified persons, maintain guarding of energized parts within a compartment during operation and maintenance functions to prevent accidental contact with energized parts and dropped tools. **2340.17(d)**
  - b. Install barriers to prevent employees not working on the equipment from contacting exposed live parts when there is temporary removal of guards. **2340.17(e)**
  - c. Protection from flames and electric arcs during construction, operation, and maintenance of electric power generation, control, transformation, transmission, and distribution lines and equipment, including related equipment for the purpose of communication or metering that are only accessible to qualified employees. **2320.11**
5. Making connections. **2320.2(b)**
  6. Minimum approach distance. **2320.2(d)**
  7. Fall Protection. **2320.8**
- C. General requirements for high-voltage systems (>600 V). **2940**
1. Voltage determination. **2940.1**
  2. Minimum approach distances. **2940.2**
    - a. **Article 36 Appendix A**—working on exposed energized parts
  3. Tools and protective equipment. **2940.6**
    - a. **Article 36 Appendix C**—protective equipment
  4. Mechanical equipment. **2940.7**
  5. Protection from flames and electric arcs during construction, operation, and maintenance of electric power generation, control, transformation, transmission, and distribution lines and equipment, including related equipment for the purpose of communication or metering that are only accessible to qualified employees. **2940.11**
    - a. **Article 36 Appendix D**—protection from flames and electric arcs
  6. Making connections. **2940.12**
  7. Hazardous energy control procedures. **2940.13**
  8. De-energizing lines and equipment for employee protection. **2940.14**
  9. Grounding for the protection of employees. **2940.15**
  10. Safe work practices for high-voltage/power testing performed in laboratories, shops, substations and in the field, and on electric transmission and distribution lines and equipment. **2940.16**
  11. The disconnection and discharging of capacitors. **2940.17**
  12. Ensure that employees do not open the secondary of a current transformer while the transformer is energized. If it cannot be de-energized, then the circuit must be bridged so that the current transformer secondary does not experience an open-circuit condition. **2940.18**
  13. Series street lighting work. **2940.19**
  14. Work on or in proximity to overhead lines. **2941**
  15. Work on or in proximity to underground cables, conductors, or equipment. **2943**
  16. Work on or in proximity to conductors and equipment located in stations or switchyards. **2944**
  17. Work in power generation plants **2944.1**
  18. Access and workspace requirements. **2945**
  19. Live line tools. Appendix B
  20. Protection from hazardous differences in electrical potential. Appendix E
  21. Line clearance (tree trimming) operations. **2951**
- D. Main service equipment
- Whenever the electric utility provides service via overhead lines, the installation must:
1. Consist of an acceptable service pole. **2405.3**
  2. Be suitably grounded. **2395.5(b)**
  3. Provide suitable overcurrent protection. **2390.1**
- E. Wiring methods and devices
1. Flexible cords may be used in place of permanent wiring methods for temporary work if the cords are equipped with an attachment plug and energized from an approved



receptacle. **2500.7(a), (b)**

2. Flexible cords must be Type S and cannot be spliced unless they are size No. 12 (or larger). **2500.9(a)**
3. Skirted attachment plugs must be used on all equipment operating at more than 300 V. **2510.7(b)**

*Exception: Plugs or connectors so designed that the arc will be confined within the body or case of the device shall be acceptable.*

#### F. Grounding

1. Each receptacle must have a grounding contact that is connected to an equipment-grounding conductor. **2510.7(a)**
2. Temporary wiring must be grounded. **2405.2(g)**
3. Electrically powered tools and electrical equipment with exposed, non-current-carrying metal parts must be grounded. **2395.45(b)**  
*Exception: Double insulated powered tools need not be grounded. 2395.45(b)*
4. The frame of a portable generator and the frame of a vehicle where the generator is located need not be grounded under certain conditions. **2395.6**
5. A system conductor shall be bonded to the generator frame where the generator is a component of a separately derived system. **2395.6(c)**

#### G. Ground-fault circuit interrupters (GFCIs)

The GFCI device senses ground faults (accidental electrical paths to ground) in circuits and immediately cuts off all electrical power in that circuit.

1. GFCIs are required on receptacles that are not connected to the site's permanent wiring and that have a rating of 15 or 20 amps, 120V, AC, single phase. **2405.4(c)**
2. The assured equipment grounding conductor program (AEGC program) is an approved alternative to the GFCI requirement if the following program elements are included: **2405.4(d)**
  - a. A description of the program must be written.
  - b. The employer shall designate one or more qualified persons to implement the program.

c. Daily visual inspection of included equipment must be conducted.

d. The following tests shall be performed:

- (1) All equipment-grounding conductors shall be tested for continuity and shall be electrically continuous.
- (2) All plugs and receptacles must be tested for proper attachment to the equipment grounding conductor.

e. The tests shall be performed as follows:

- Before the first use of newly acquired equipment.
- Before equipment is returned to service.
- Before equipment is used after an incident that may have caused damage.
- At intervals not to exceed three months.

f. The employer shall not make available or permit the use of equipment that has not met the requirements of **2405.4(d)**.

g. A means of identifying tested equipment shall be provided.

#### H. High-voltage power lines (> 600 V)

1. Great care must be taken when working or operating equipment near overhead high-voltage power lines.
2. The required minimum safe distances (clearance) from overhead lines energized by 600 V to 50,000 V are: **2946**
  - a. For boom-type equipment in transit, 6 ft.
  - b. For boom-type equipment in operation, 10 ft.
  - c. For people working near overhead lines, 6 ft.

*Note: See 2946 for minimum required clearances from voltages greater than 50,000 V.*

3. Amusement rides or attractions shall not be located under or within 15 ft. (4.57 m) horizontally of conductors operating in excess of 600 volts. **2946(b)(2)**
4. The following activities are prohibited unless overhead power lines have been de-energized and visibly grounded:
  - a. Work over high-voltage lines. **2946(b)(1)**

- b. Work within required clearances. **2946(b)(2)**

*Note: When work is to be performed within minimum required clearances, the operator of the high-voltage line must be notified by person or persons responsible for the work before proceeding with any work, which would impair the aforesaid clearance. **2948***

- I. High-voltage warning signs. **2947**

High-voltage warning signs must be posted in plain view of equipment operators.

- J. Lock-out procedures

Lock-out procedures must be followed during the cleaning, repairing, servicing, or adjusting of machinery. GISO **3314**, ESO **2320.4(a)(2)**

- K. Provide medical services and first aid as required in General Industry Safety Orders, section 3400. In addition, CPR and First Aid trained personnel also must be available as per **2320.10**, **2320.10(c)**.

- I. Landings must be provided at the top floor and at least at every third floor. **1630(d)**
- J. Landing doors must be mechanically locked so that they cannot be opened from the landing side. A hook-and-eye lock is prohibited. **1604.6(b)**
- K. For hoists located outside of a structure, the hoistway enclosures must be 8 ft. high on the building side or the scaffold side at each floor landing and 8 ft. high on all sides of the pit. **1604.5(c)**
- L. Hoistway doors shall be at least 6 1/2 ft. high. Solid doors must contain a vision panel. (See **1604.6(a)** for specific requirements) **1604.6(a)**.
- M. During inspection and maintenance, the car shall be operated at the slowest speed. In-car operating devices shall not function when car top operation is selected. The car top operating devices shall include an emergency stop button. The tops of cars shall be enclosed by a standard guardrail and toeboard as per **3209**. **1604.24**.

*Exception: See **1604.24(a)(3)(D)**.*

## Elevators, Lifts, and Hoists

Construction elevator and personnel hoist requirements are as follows:

- A. An elevator is required for structures or buildings 60 ft. or more above ground level or 48 ft. below ground level when completed. The elevator must be installed when the structure or building reaches 36 feet in height. **1630(a)(1)**
- B. An elevator is required at demolition sites of seven or more stories or 72 ft. or more in height. **1735(r)**
- C. Use of endless-belt-type manlifts is prohibited. **1604.1(a)**
- D. Before use, construction elevators must be inspected and tested in the presence of a DOSH representative. A permit to operate is required. **1604.29(a)**
- E. Ropes must be inspected at least once every 30 days, and records of these inspections must be kept. **1604.25(j)**
- F. A capacity plate must be posted inside the car. **1604.21(b)**
- G. Elevators must be operated only by competent, authorized persons. **1604.26(c)**
- H. Installation must comply with **1604**.

## Emergency Medical Services

Emergency Medical Services (EMS) must be readily available. **1512(a), (e)**

- A. A first aid kit must be provided by each employer on all job sites and must contain the minimum of supplies as determined by an authorized licensed physician or as listed in **1512(c)**. The contents of the first-aid kit shall be inspected regularly to ensure that the expended items are promptly replaced. **1512(c)(1)**
- B. Trained personnel in possession of a current Red Cross First Aid certificate or its equivalent must be immediately available at the job site to provide first aid treatment. **1504(a)**, **1512(b)**
- C. Each employer must ensure that its employees have access to emergency medical services at the job site. Where more than one employer is involved in a single construction project on a given construction site, the employers may agree to ensure employee access to emergency medical services for the combined workforce present at the job site. **1512(a)**
- D. Each employer shall inform all of its employees of the procedure to follow in case of injury or illness. **1512(d)**

- E. Employer shall have a written plan to provide emergency medical services. **1512(i)**  
 Medical services and first aid in electrical works shall also comply with the requirements of ESOs, as applicable. **2320.10, 2940.10**
- F. Proper equipment for prompt transport of the injured or ill person to an EMS facility or an effective communication system for calling an emergency medical facility, ambulance, or fire service must be provided. Telephone numbers for listed emergency services must be posted (see Cal/OSHA poster S-500). **1512(e)**
- G. Exposure to bloodborne pathogens is considered a job-related hazard for construction workers who are assigned first aid duties in addition to construction work. Although construction employers are specifically exempted from GISO **5193** requirements, they are required to provide appropriate protection for employees who may be exposed to bloodborne pathogens when providing first aid. **3203**

## Engine Exhaust Emission

Extreme care must be taken when engine exhaust can build up in work spaces, such as confined spaces, excavations, trenches, and inside buildings or enclosed structures.

- A. Exhaust purifier devices approved by DOSH or California Air Resources Board (CARB) must be used to maintain concentrations of dangerous gases or fumes below maximum acceptable concentrations if natural or forced dilution ventilation and exhaust collection systems are inadequate. **5146**  
*Note: Approval by DOSH will be based on the Maximum Allowable Standards for Internal Combustion Engine Exhaust Emissions as set forth in **5146(c)**.*
- B. When employees enter shafts (20 ft. or less), culverts, or pipelines where a hazardous atmosphere exists or is reasonably expected to exist, a mechanical ventilation system shall be provided to prevent exposure to engine emissions. **1533(b)**
- C. Internal combustion engine-driven equipment can be operated inside buildings or enclosed structures only when it does not result in exposure to dangerous gases or fumes as per **5155. 1533(a)**.

- D. Use of internal combustion engines in tunnels is prohibited. **7070(a)**  
*Exception: Diesel engines may be used in underground tunnels if the engines are permitted by DOSH. **7069, 7070, 8470***

## Erection and Construction

Every year many workers lose their lives or are seriously injured when they fall or are crushed or struck because the structure they are erecting shifts or collapses. The following SOs address these hazards:

- A. Truss and beam requirements
  1. Trusses and beams must be braced laterally and progressively during construction to prevent buckling or overturning. The first member shall be plumb, connected, braced, or guyed against shifting before succeeding members are erected and secured to it. **1709(b)**
  2. An erection plan and procedure must be provided for trusses and beams more than 25 ft. long. The plan must be prepared by a California-registered Professional Engineer, and it must be followed and kept available on the job site for inspection by Cal/OSHA staff. **1709(d)**
- B. Structural steel erection **1710**
  1. A load shall not be released from its hoisting line until the solid web structural members are secured at each connection with at least two bolts (of the same size/ strength as indicated in the erection drawings) and drawn wrench-tight. **1710(g)(1)**
  2. Steel joists or steel joist girders shall not be placed on any support structure until the structure is stabilized. **1710(h)(1)(D)**
  3. When steel joist(s) are landed on a structure, they shall be secured to prevent unintentional displacement prior to installation. **1710(h)(1)(E)**
  4. Floors must be planked at every other story or 30 ft., whichever is less. **1635(b)(3), 1710 (l)(7)**
  5. A floor must be installed within two floors below any tier of beams on which erection, riveting, bolting, welding, or painting is being done; otherwise, fall protection is required. **1635(b)(2)**

6. Fall protection is required when workers are connecting beams where the fall distance is greater than two stories or 30 ft., whichever is less. **1710(m)(1)**
- Note: At heights over 15 ft. and up to 30 ft., workers performing connecting operations must wear personal fall protection that gives them the ability to tie off.*
7. During work other than connecting operations, fall protection is required where the fall distance is greater than 15 ft. **1710(m)(2)**
8. Before any steel erection begins, the controlling contractor must provide the steel erector written notifications related to concrete strength and anchor bolt repair/replacement. **1710(c)**
9. Prior to removal of planking or metal decking, all employees must be instructed in the proper sequence of removal and safety. **1635(b)**
10. Requirements for the working area where floor openings are to be uncovered: **1635(c)**
- The area must be in the exclusive control of steel erection personnel and shall be barricaded to prohibit unauthorized entry.
  - The floor area adjacent to the floor opening shall be barricaded or the floor opening shall be covered when not attended by steel erection personnel.
  - Floor openings shall be guarded by either temporary railings and toeboards or by covers. **1632(b)(1)**
  - Covers shall:
    - Be capable of safely supporting the greater of 400 pounds or twice the weight of the employees, equipment, and materials that may be imposed on any one square foot area of the cover at any time. **1632(b)(3)**
    - Have not less than 12 inches of bearing on the surrounding structure. **1635(c)(3)**
    - Be checked by a qualified person prior to each shift and following strong winds. **1635(c)(5)**
    - Never be removed by walking forward where the walking surface cannot be seen. **1635(c)(6)**
    - Bear a sign stating "OPENING—DO NOT REMOVE" in 2-inch-high, black bold letters on a

yellow background. **1635(c)(4)**

11. Permanent Flooring-Skeleton Steel Construction in Tiered Buildings

Unless the structural integrity is maintained by the design **1710(k)**:

- There shall be not more than eight stories between the erection floor and the uppermost permanent floor.
- There shall be not be more than four floors or 48 ft., whichever is less, of unfinished bolting or welding above the foundation or uppermost permanently secured floor.

12. All columns must be anchored by a minimum of four anchor bolts. **1710(f)(1)(A)**

*Exception: When columns are braced or guyed to provide the stability to support an eccentric load as specified in **1710(f)(1)(B)**.*

*Note: Persons engaged in steel erection should review and be knowledgeable in all the requirements contained in section **1710**.*

C. Wood/light gauge steel, residential and light commercial frame construction

- Joists, beams, or girders of floors below the floor or level where work is being done, or about to be done, must be covered with flooring laid close together. **1635(a)(1)**
- Employees shall not work from or walk on structural members until they are securely braced and supported. **1716.2(d)**
- Before manually raising framed walls that are 15 ft. or more in height, temporary restraints, such as cleats on the foundation or floor system or straps on the wall bottom plate, must be installed to prevent inadvertent horizontal sliding or uplift of the framed wall bottom plate. Anchor bolts alone shall not be used for blocking or bracing when raising framed walls 15 ft. or more in height. **1716.2(c)**
- When installing windows, wall openings shall be guarded as required by **1632**; however, the guardrail may be removed for actual window installation if necessary. **1716.2(h)**
- Scaffolds used as an edge protection platform must be fully planked, not more than 2 ft. below the top plate,

and located no more than 16 inches from the structure. **1716.2(i)(3)**

6. Employees exposed to fall hazards must be trained to recognize and minimize the fall hazard. **1716.2(j)**
  7. Employees performing framing activities who are exposed to fall heights of 15 ft. or greater must be protected by guardrails, personal fall protection systems, or other effective means. **1716.2(e)**
- D. Reinforcing steel and post-tensioning in concrete construction:
1. Know and understand T8 CCR sections **1711, 1712, 1713, and 1717**.
    - a. Site access and layout. **1711(c)**
    - b. Written notifications. **1711(d)**
    - c. Stability requirements for vertical and horizontal columns, walls, and other reinforcing assemblies. **1711(e)**
    - d. Impalement protection and custody of protective covers. **1711(f)** and **1712**
    - e. Requirements for hoisting and rigging reinforcement assemblies. **1711(g)**
    - f. Post-tensioning operations. **1711(h)**
    - g. Fall protection. **1711(i)**
    - h. Formwork and falsework. **1711(j)**
    - i. Training Requirements. **1711(k)**
    - j. Framed panels and concrete forms. **1713**
    - k. Falsework and vertical shoring. **1717**

## Ergonomics in Construction

Ergonomics is the study of improving the fit between the worker and the physical demands of the workplace. Ergonomics can be used to reduce injuries, improve productivity, and reduce the costs of doing business.

The construction industry suffers from debilitating and costly occupational injuries, primarily to workers' backs, necks, shoulders, hands, and arms. These types of injuries or traumas

are commonly called repetitive motion injuries (RMIs) and are caused by activities that are repeated on a regular basis. Symptoms of RMIs may include chronic pain, numbness, tingling, weakness, and limited range of motion. RMI symptoms may not be noticeable for months or even years after exposures, or may appear to be acute after a sudden and severe onset.

### A. Factors that can contribute to RMIs:

1. Awkward postures
2. Forceful exertion, including heavy lifting
3. Repetitive work
4. Vibration from tools and equipment
5. Pinching (contact stress) during tool use and material handling
6. Temperature extremes
7. Lack of recovery time to affected body parts

*Note: Repeated localized fatigue or soreness after completion of the same task or day's work often indicates that the worker is being exposed to conditions that can lead to RMIs.*

- B. Knowledge of ergonomic principles can be used to produce simple changes in the workplace and work activities, which in turn can avoid injury, improve productivity, and make jobs easier. The requirements that employers must follow include the following: **5110**
1. Employers must establish and implement a program designed to minimize RMIs if more than one person is diagnosed with RMIs as follows:
    - a. The RMIs are work related.
    - b. The employees incurred the RMIs while performing a job process or operation of identical work activity.
    - c. The RMIs were reported in the past 12 months.
    - d. A licensed physician objectively identified and diagnosed the RMIs. **5110(a)**
  2. The program must include the following:
    - a. A work site evaluation.
    - b. Control of exposures that caused the RMIs.
    - c. Training of employees. **5110(b)**

C. Some ways to eliminate or reduce RMIs:

1. Proper lifting and material handling
2. Use of equipment to reduce load and strain
3. Employee rotation for repetitive tasks
4. Use of ergonomically designed tools
5. Use of personal protective equipment
6. Appropriately timed rest periods

D. Employer should regularly scrutinize the 300 Log to see whether multiple cases of RMI's are being reported. If an employer fails to monitor for such patterns of illness, as reported on the Log, the employer might fail to identify that two or more RMI cases have occurred in the past year, and therefore fail to meet the triggered requirement for more careful assessment of ergonomic risks.

## Excavation, Trenches, and Earthwork

Hazards associated with excavation are cave-ins; the striking of underground utilities; falling tools, materials, and equipment; and hazardous air contaminants or oxygen-deficient environments.

A. The minimum safety requirements are as follows:

1. Before opening an excavation, these actions must be taken: **1541**
  - a. Must identify subsurface installations prior to opening an excavation and ensure they are marked.
  - b. Two working days before starting the work, notify all regional notification centers and all subsurface installation owners who are not members of the notification centers.  
*Exception: Emergency repair work to subsurface facilities done in response to an emergency, as defined in Government Code section 4216(d).*
  - c. Must receive a positive response from all known owners/operators of subsurface installations.
  - d. Must meet with owners/operators of high priority (such as high-pressure pipelines, natural gas/petroleum pipelines, electrical lines greater than 60,000 volts, etc.)

and subsurface installations that are located within 10 ft. of the proposed excavation.

- e. Only qualified persons (persons that meet training and competency requirements) can perform subsurface installation locating activities.
- f. All exposed employees must be trained in excavator notification/excavation activities.
- g. Obtain a permit from DOSH if workers are required to enter an excavation that is 5 ft. deep or deeper. **341(a)(1)**

2. While excavating, the exact locations of the underground utilities must be determined by safe and acceptable means. **1541(b)(3)**
3. Excavators must immediately notify the subsurface installation owner/operator of any damage discovered during or caused by excavating activities. If the damage or escaping material endangers life or property, immediately notify 911.
4. While the excavation is open, the underground utilities must be protected, supported, or removed as necessary. **1541(b)(4)**

B. When employees are in an excavation, the following requirements apply:

1. Employees shall be protected from cave-ins by an appropriate protective system. **1541.1(a)(1)**

*Exception: If excavations are made entirely in stable rock or are less than 5 ft. deep, and a competent person has determined that there is no potential for a cave-in, no protective system is needed.*

2. A competent person must be on site to do the following:
  - a. Conduct inspections of the excavations, adjacent areas, and protective systems before the start of work, as needed throughout the shift, and daily for potential cave-ins, failures, hazardous atmospheres, or other hazards. **1541(k)(1)**
  - b. Take prompt corrective action or remove employees from the hazard.
3. The competent person must be able to demonstrate the following:
  - a. The ability to recognize all possible hazards associated

with excavation work and to test for hazardous atmospheres.

- b. Knowledge of the current safety orders pertaining to excavation and trenching.
  - c. The ability to analyze and classify soils.
  - d. Knowledge of the design and use of protective systems.
  - e. The authority and ability to take prompt corrective action when conditions change.
- C. Requirements for protective systems include the following:
1. Protective system design must be based on soil classification: Stable rock, Type A, B, or C soils. **1541.1 Appendix A (b), (c)**
  2. Soil classification is required as follows unless the protective system design is based on Type C soil:
    - a. Classification must take into account both site and environmental conditions. **1541.1 Appendix A (a)(1)**
    - b. Soil must be classified by a competent person as Type A, B, or C soil. **1541.1 Appendix A (c)(1)**
    - c. Classification must be based on the results of at least one visual and at least one manual analysis. **1541.1 Appendix A (c)(2)**

**Table 1 | Site Conditions That Affect Rock/Soil Slope Stability**

| Condition   | Requirement  |
|---|--|
| Soil is fractured/unstable dry rock.  | Downgrade to Type B.   |
| Soil is fractured/unstable submerged rock.  | Downgrade to Type C.   |
| Soil is cemented (caliche, hardpan, etc.)   | Classify as Type A.  |
| Soil is fissured.   | Downgrade from Type A to Type B.                                     |
| Soil is subject to vibration.   | Downgrade from Type A to Type B.                                     |
| Soil has been previously disturbed.   | Downgrade from Type A to Type B.                                     |
| Soil is submerged or water is freely seeping through the sides of the excavation.                             | Downgrade from Type A to Type C.<br>Downgrade from Type B to Type C. |
| Soil profile is layered with the layers dipping into the excavation on a slope of four horizontal or steeper. | Downgrade from Type A to Type C.<br>Downgrade from Type B to Type C. |

Illustration 5

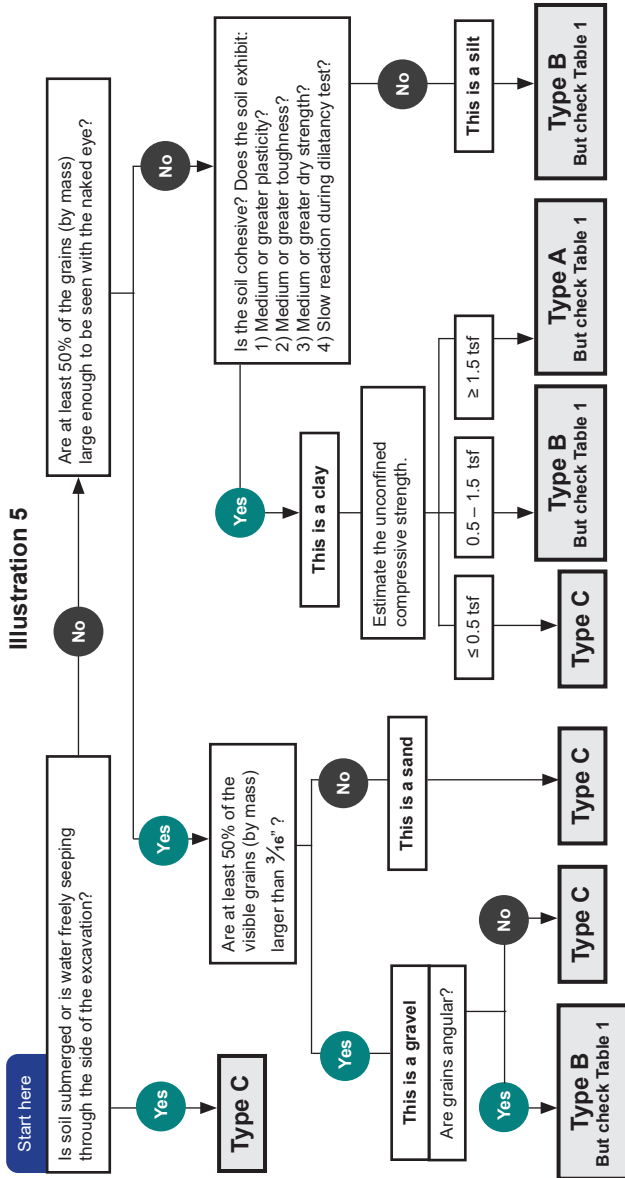

3. Standard shoring, sloping, and benching must be used as specified in **1540** and **1541.1(b)** or according to tabulated data prepared by a registered engineer (see Illustrations 6–8 below).
4. Protective systems for excavations deeper than 20 ft. shall be designed by a registered engineer. **1541.1 Appendix F**
5. Additional bracing must be used when vibration or surcharge loads are a hazard. **1541.1 Appendix A**
6. Excavations must be inspected as needed after every rainstorm, earthquake, or other hazard-increasing occurrence (water in the excavation may require a reclassification of soil type). **1541(k)(1)**
7. Employees must be protected from falling materials by scaling, installation of protective barriers, or other methods. **1541(j)(1)**
8. Uprights shall extend to the top of the trench and its lower end not more than 2 feet from the bottom of the trench. **1541(j)(1)**
9. Employees must be protected from excavated or other material by keeping such material 2 ft. from the excavation edge or by using barrier devices. **1541(j)(2)**
10. Ladders or other safe access must be provided within 25 ft. of a work area in trenches 4 ft. or deeper. **1541(c)(2)**
11. Excavation beneath the level of adjacent foundations, retaining walls, or other structures is prohibited unless requirements of **1541(i)** have been met. **1541(i)(1)**
12. Shored, braced, or underpinned structures must be inspected daily when stability is in danger. **1541(i)(2)**
13. Walkways or bridges with standard guardrails must be installed when employees or equipment are required or permitted to cross over excavations that are at least 6 ft. deep and wider than 30 in. **1541(l)(1)**
14. Barriers must be erected around excavations in remote locations. All wells, pits, shafts, and caissons must be covered or barricaded, or if temporary, backfilled when work is completed. **1541(l)(2)**



Illustration 6 | Benching & Sloping For Excavations Made in Type "A" Soil

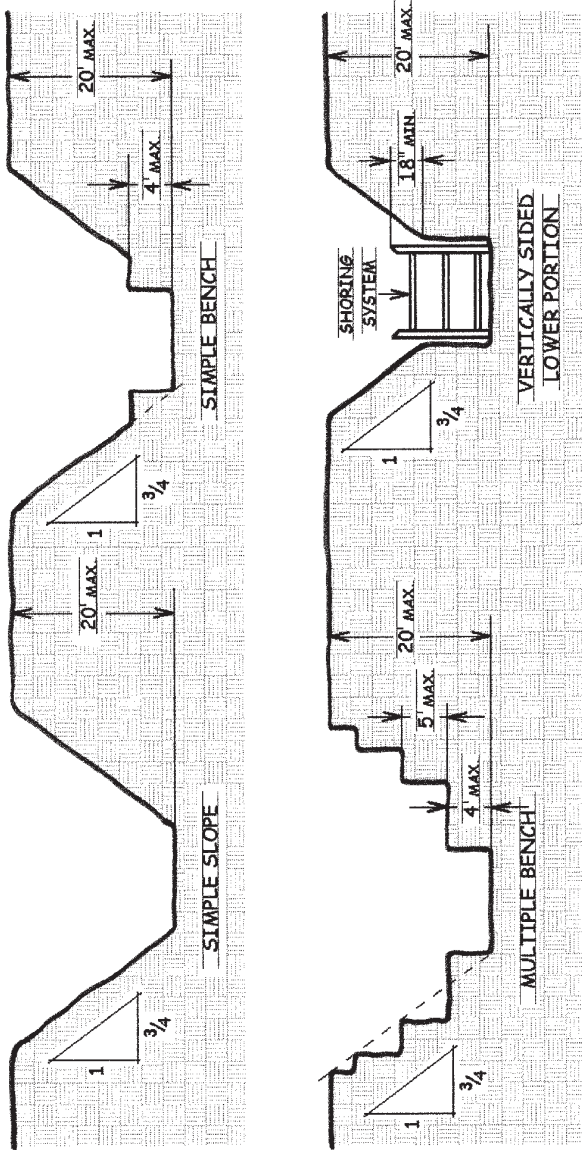
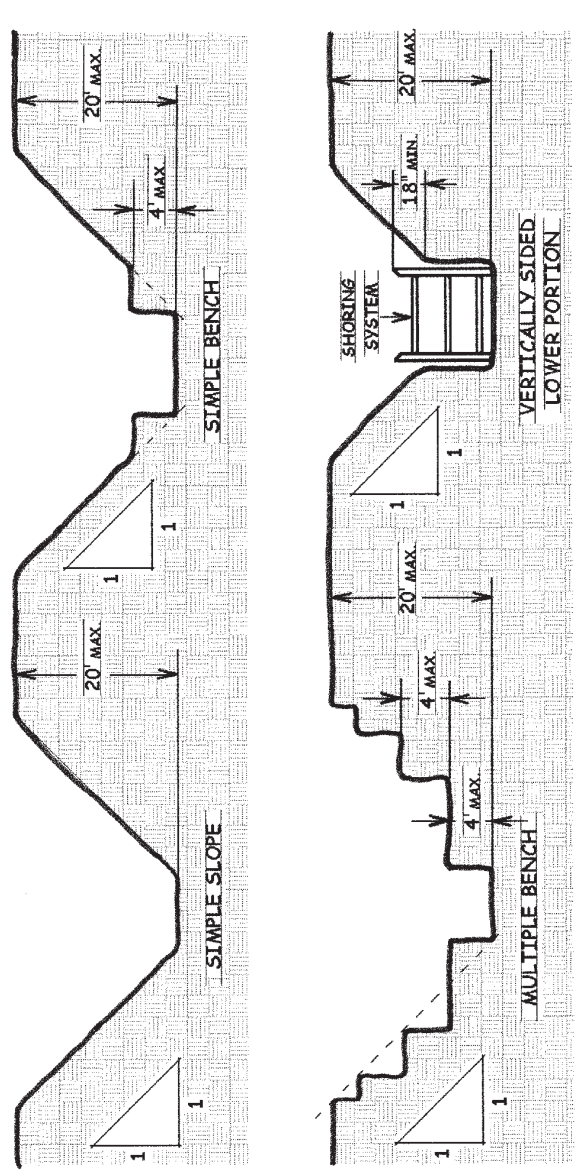
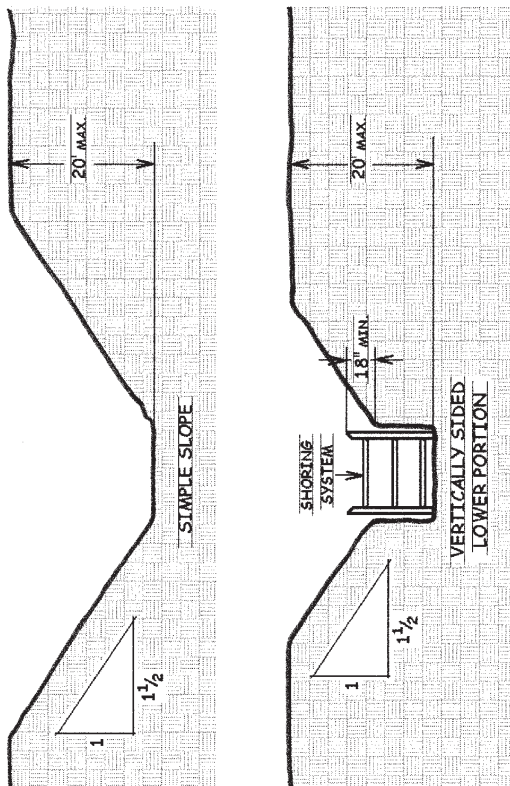

Illustration 7 | Benching & Sloping For Excavations Made in Type "B" Soil



## Illustration 8 | Benching & Sloping for Excavations Made in “Type C” Soil



- D. Safety orders pertaining to shafts and wells include the following:
1. All shafts and wells more than 5 ft. deep into which workers are required to enter must be retained with lagging, spiling, or casing. **1542(a)(1)**
  2. Tests or procedures shall be performed before entry into exploration shafts to ensure the absence of dangerous air contamination or oxygen deficiency. **1542(c)(3), 5158**

3. An employee entering a bell-bottom pier hole or other deep or confined-footing excavation shall wear a harness that has a lifeline attended by another employee. **1541(g)(2)(B)**
4. Shafts in other than hard, compact soil shall be completely lagged and braced. **1542(c)(1)**
5. Head protection is required for workers who enter a well or shaft. **3381**
6. Shafts more than 20 ft. deep are subject to the TSOs. **8403(a)**
7. Provide mechanical exhaust ventilation system and forced air blower or both for shafts 20 ft. or less which employees enter and where hazardous atmosphere exists or reasonably expected to exist due to internal combustion engine operation. **1533(b)**

## Explosion Hazards

At times, employees may be exposed to explosion hazards without their knowledge. In addition to substances (such as dynamite) that are designed specifically for the purpose of creating explosions, there are substances that will cause an explosion when present in certain concentrations and exposed to an ignition source. SOs to control these hazards include:

- A. Combustible dust:
1. Combustible dust concentrations must be controlled at or below 25% of the lower explosive limit (LEL) unless all ignition sources are eliminated or identified and specifically controlled. **5174(a)**
  2. Accumulated and settled combustible dusts must be cleaned up to prevent a fire or explosion. **5174(b)**
  3. Cleaning with compressed air and blowing combustible dust may be done only when other methods cannot be used, when possible sources of ignition have been eliminated, and when hoses and nozzles are grounded. **5174(f)**
- B. Flammable vapors:
1. Ventilation in enclosed places must be sufficient to prevent flammable vapor or gas concentrations from exceeding 25% of the LEL. **5416(a)**

2. No source of ignition is permitted indoors or outdoors where vapor or gas concentrations may reasonably be expected to exceed 25% of the LEL. **5416(c)**
3. Employers need to be aware that most flammable vapors are toxic even at a very low concentration and can cause adverse health effects. Employers must have control measures to keep employees safe.

*Note: Check also for confined space conditions and hazardous locations. **5158, 2540.1, Confined Spaces section of this guide.***

## Fall Protection

T8 CCR includes fall protection standards in various sections of the GISOs, CSOs, TSOs, and ESOs. These standards reflect the levels of the fall hazards associated with each activity.

A. The factors affecting the level of hazard include the following:

1. Fall height
2. Level of hazard awareness and skill of the employee
3. Physical work environment (e.g., conditions affecting the stability of the employee on the work surface)
4. Duration of exposure to the fall hazard

*Note: Because factors 2, 3, and 4 listed above vary with different trades and activities, the regulatory requirements for fall protection reflect those differences. Below find definitions and selected fall protection requirements:*

B. A personal fall protection (PFP) system prevents a worker from falling or—if the worker is falling—stops the fall. PFP systems include guardrails, safety nets, personal fall restraint systems, personal fall arrest systems, and positioning device systems.

1. Guardrails are required to guard the open sides of all work surfaces that are 7 1/2 ft. or higher or workers must be protected by other means. The railing must be made from select lumber (Doug Fir#1 or better, 1500 psi or equivalent) and must consist of a top rail 42 inches to 45 inches high, 2" x 4" (min.); a 1" x 6" mid-rail halfway between the top rail and the floor; and support posts at least 2" x 4" at 8 ft. o.c.
2. A personal fall restraint (PFR) system is used to prevent

an employee from falling. It consists of anchorages, connectors, and a body belt or harness. It may include lanyards, lifelines, and rope grabs designed for that purpose.

3. A personal fall arrest (PFA) system is used to stop an employee during a fall from a working level and to keep him or her from hitting a lower level or structure. The system consists of an anchorage, connectors, and a body harness. It may include a lanyard, a lifeline, a deceleration device, or suitable combinations of these. A PFA system must meet the following requirements:

- a. It must limit the maximum arresting force on an employee to 1,800 lbs.
- b. It must be rigged so that an employee can neither free fall more than 6 ft. nor contact any lower level, and, where practicable, the anchor end of the lanyard shall be secured at a level not lower than the employee's waist.
- c. Anchorage points must be able to support 5,000 lbs. per employee attached or:
  - (1) Must be designed, installed, and used as part of a complete PFA system with a safety factor of two; and
  - (2) Under the supervision of a qualified person.
- d. The PFA system lifeline must meet the following requirements: **1670(b)**
  - (1) It must be able to support 5,000 lbs.
  - (2) Each employee must be attached to a separate lifeline. **1670(b)(4)**

*Exception: During the construction of elevator shafts, two employees may be attached to a lifeline that is able to support 10,000 lbs.*

- (3) The lower end of the vertical lifeline must extend to within 4 ft. from the ground. **1504**
- (4) A horizontal lifeline system must be designed, installed, and used under the supervision of a qualified person and maintained with a safety factor of at least two. **1670(b)(2)**

*Note: The use of a body belt as a part of a PFA system is prohibited. **1670(b)***

4. Body belts, harnesses, and components shall be used only for employee protection and not to hoist materials. Body belts used in conjunction with fall restraint systems or positioning devices shall limit the maximum arresting force on an employee to 900 lbs. **1670(b)**
5. Safety nets may be used in place of all other fall protection systems if the nets are installed properly. **1671**

C. A PFP system compliant with section 1670 must be used if guardrails or safety nets are not installed for the following fall distances and work activities:

1. A fall distance of more than 6 ft. when placing or tying reinforcing steel in walls, columns, piers, etc. **1711(i)**

*Exception: Reinforcing ironworkers may travel point-to-point horizontally or vertically on reinforcing steel up to 24 ft. above the surface provided there are no impalement hazards.*

2. A fall distance of 7 1/2 ft. or greater during the following:
  - a. Work from the perimeter of a structure, through shaftways and openings. **1670(a)**
  - b. Work anywhere on roofs with slopes greater than 7:12. **1670(a)**
  - c. Work from thrust-outs or similar locations when the worker's footing is less than 3 1/2 inches wide. **1669(a)**
  - d. Work on suspended staging, floats, catwalks, walkways, or advertising sign platforms. **1670(a)**
  - e. Work from slopes steeper than 40 degrees. **1670(a)**
3. A fall distance of 15 ft. or greater during the following:
  - a. Work from buildings, bridges, structures on construction members, such as trusses, beams, purlins, or plates that are of at least 4-inch nominal width. **1669(a)**
  - b. Ironwork other than connecting. **1710(g)(2)**
  - c. Work on structural wood framing systems and during framing activities on wood or light gauge steel frame residential/light commercial construction. **1716.1(c)(1)**, **1716.2(e)**

*Exception: For residential/light commercial frame construction, workers are considered protected when working on braced joists, rafters, or roof trusses spaced*

*on 24-inch (or less) centers when they work more than 6 ft. from unprotected sides or edges.*

4. An eave height of 20 ft. or greater, during all roofing operations (see exceptions in 2a above and 6a and 6b below). **1730(b)**
5. A fall distance of 30 ft. or greater, when ironworkers are connecting structural beams. **1710(g)(1)**
6. Any height during work:
  - a. On roofs sloped steeper than 7:12, the air hose for the pneumatic nailer shall be secured at roof level in such a manner as to provide ample, but not excessive, amounts of hose. **1704(d)**
  - b. On roofs, while an operator uses a felt-laying machine or other equipment that requires the operator to walk backwards (see prohibitions). **1730(d)**
  - c. From boatswain's chairs. **1662(c)**
  - d. From float scaffolds. **1663(a)(5)**
  - e. From needle-beam scaffolds. **1664(a)(12)**
  - f. From suspended scaffolds. **1660(g)**
- D. A fall protection plan (FPP) must be implemented when a fall protection (FP) system is required but cannot be used because the system creates a greater hazard or is impractical. **1671.1**

The fall protection plan must: **1671.1(a)(1)**

  1. Be prepared by a qualified person (QP) who is identified in the plan.
  2. Be developed for a specific site or developed for essentially identical operations.
  3. Be updated by the QP.
  4. Document why a conventional FP system cannot be used.
  5. Identify the competent person to implement and supervise the FPP.
  6. Identify the controlled access zone for each location where a conventional FP system cannot be used.
  7. Identify employees allowed in the controlled access zone (CAZ).
  8. Be implemented and supervised by the competent person.

*Note: An up-to-date copy of the fall protection plan must be at the job site.*

- E. The controlled access zone must be established and maintained as follows: **1671.2**
1. A control line or its equivalent must control access to the CAZ and must:
    - a. Consist of ropes, wires, tapes, or equivalent materials and be supported by stanchions.
    - b. Be flagged or marked at not more than 6 ft. o.c.
    - c. Be rigged not fewer than 39 inches and not more than 45 inches from the working surface.
    - d. Have a breaking strength of 200 lbs. (min.). See **1671.2** for greater detail.
  2. Signs must be posted to keep out unauthorized persons.
  3. A safety monitoring system is required and must include a designated safety monitor who is able to:
    - a. Monitor the safety of other employees.
    - b. Recognize fall hazards.
    - c. Warn an employee when it appears that the employee is unaware of a fall hazard or is acting in an unsafe manner.
    - d. Stay in sight of and in communication with the employee being monitored.
    - e. Have no other responsibilities. **1671.2**

*Note: Only an employee covered by a fall protection plan shall be allowed in a CAZ.*

- F. Fall protection for production type residential roofing work: **1731(c)**
1. For roof slopes 3:12 through 7:12, the following applies:

Employees shall be protected from falling where the eave height exceeds 15 feet above grade or level below by use of one or any combination of methods prescribed below:

    - a. Personal Fall Protection. **1670**
    - b. Catch Platforms. **1724**
    - c. Scaffold Platforms. **1724**
    - d. Eave Barriers. **1724**

- e. Standard Railings and Toeboards. **1620, 1621**
  - f. Roof Jack Systems. **1724**
2. For roof slopes steeper than 7:12, the following applies:
- Regardless of height, employees shall be protected from falling by methods prescribed above with exception of Eave Barriers and Roof Jack Systems.
- G. Section **1730** applies to all roofing work that are not on new production-type residential construction with roof slopes 3:12 or greater. **1730(f)(6)**

## Fire Protection and Prevention

The employer is responsible for establishing an effective fire prevention program and ensuring that it is followed throughout all phases of the construction work. **1920(a)**

- A. Fire-fighting equipment must be:
1. Freely accessible at all times. **1920(b)**
  2. Placed in a conspicuous location. **1920(c)**
  3. Well-maintained. **1920(d)**
- B. A water supply that is adequate to operate fire-fighting equipment must be made available as soon as combustible materials accumulate. **1921(a)**
- C. Fire extinguisher use must comply with the following:
1. Fire extinguishers must be kept fully charged, inspected monthly, and serviced annually. **1922(a)**
  2. At least one fire extinguisher rated not less than 2A must be provided at each floor.
  3. At least one fire extinguisher rated not less than 2A must be provided adjacent to the stairway at each floor level.
  4. Fire extinguishers rated not less than 2A must be provided for each 3,000 sq. ft. of floor area or a fraction thereof.
  5. Fire extinguishers must be kept within 75 ft. of the protected area. **1922(a)**

*Exception: Fire extinguishers must be kept within 50 ft. of wherever more than 5 gal. of flammable or combustible liquid or 5 lbs. of flammable gas is being used. **1922(a)***

6. Training in the use of fire extinguishers must be provided annually. **6151(g)**

*Note: See specific SOs and manufacturing specifications for appropriate use of fire extinguishers.*

When sprinklers are provided, they shall be installed in an approved manner as per the California Fire Code, CCR, Title 24, section 903.3. **1933, 6170**

## First Aid

Regulations concerning first aid include the following:

- A. A first aid kit must be provided by each employer on all job sites and must contain the minimum of supplies as determined by an authorized licensed physician or as listed in **1512(c)**.
- B. Trained personnel in possession of a current Red Cross First Aid certificate or its equivalent must be immediately available at the job site to provide first aid treatment. **1504(a), 1512(b)**
- C. Each employer shall inform all of its employees of the procedure to follow in case of injury or illness. **1512(d)**
- D. Emergency medical services, including a written plan, must be provided. **1512(a), and (e)**
- E. Exposure to bloodborne pathogens is considered a job-related hazard for construction workers who are assigned first aid duties in addition to construction work. Although construction employers are specifically exempted from GISO **5193** requirements, they are required to provide appropriate protection for employees who may be exposed to bloodborne pathogens when providing first aid. **3203**

## Flaggers

Flaggers must be used at locations on a construction site as soon as barricades and warning signs cannot effectively control moving traffic. The employer must ensure the following:

- A. Flaggers must be placed in locations so as to give effective warning. **1599(b)**
- B. Worksite traffic controls and placement of warning signs must conform to the requirements of the "California Manual on Uniform Traffic Control Devices for Streets and Highways,

January 13, 2012" (the Manual), published by Caltrans. **1598(a), and 1599(c)**

- C. Warning signs must be placed according to the "The Manual." **1599(c)**
- D. Flaggers must wear orange or strong yellow-green warning garments, such as vests, jackets, shirts, or rainwear. **1599(d)**
- E. The employer shall select the proper type (class) of high-visibility safety apparel for a given occupational activity by consulting "The Manual," apparel manufacturer, ANSI/ISEA 107-2004, Appendix B or the American Traffic Safety Services Association (ATSSA). **1599(f)**
- F. Flaggers shall wear warning garments manufactured in accordance with the requirements of ANSI/ISEA 107-2004, High Visibility Safety Apparel and Headwear. **1599(d)**
- G. During the hours of darkness: **1599(e)**
  - The flagger shall be clearly visible to approaching traffic and be outfitted with reflectorized garments manufactured in accordance with the requirements of the ANSI/ISEA 107-2004, High Visibility Safety Apparel and Headwear.
  - The retroreflective material shall be visible at a minimum distance of 1,000 ft.
  - During snow or fog conditions, only colored vests, jackets, and/or shirts with retroreflective material that meets the ANSI/ISEA and the minimum distance requirements shall be worn.
- H. Flaggers must be trained. **1599(g)**
- I. Training must be documented in accordance with the IIPP requirements. **1599(g)**

## Flammable and Combustible Liquids

Flammable and combustible liquids include gasoline, paint thinners, solvents, etc.

- A. These liquids must be kept in closed containers when not in use. **1935(a)**
- B. Leakage or spillage must be disposed of promptly and safely. **1935(b)**

- C. Flammable and combustible liquids may be used only where no open flames or sources of ignition exist (see specifics in **1935(c)**)
- D. All containers of flammable and combustible liquids must be plainly marked with a warning legend. **5417(a)**
- E. Flammable liquids must not be used: **5417**
  - To wash floors, structures, or equipment except where there is adequate ventilation
  - To spray for cleaning purposes unless the liquids are used in a spray booth or outdoors where there is no ignition source within 25 ft. of their use
- F. Flammable liquids must be stored and transported in closed containers. **5417(e)**

*Note: For specific requirements concerning indoor and outdoor storage, see 1931 and 1932. For on-site dispensing operations, see 1934.*
- G. A hazard communication program is required. **5194**

## Forklifts

Safety regulations concerning the use of forklifts are as follows:

- A. Industrial trucks such as forklifts shall be designed, constructed, and maintained in accordance with the applicable standards. **3650(c)**
- B. The employer shall establish and enforce a system to prevent trucks, trailers, or railcars from pulling away from the loading dock before the loading or unloading operation is completed. Trucks, trailers, and railcars boarded by forklifts during loading dock operations shall be secured against unintended movement. **3336**
- C. The rated lifting capacity of the forklift must be posted in a location readily visible to the operator. **3660(a)**
- D. Elevating employees requires the following:
  1. The forklift must be equipped with a platform not less than 24" x 24" in size.
    - a. The platform must be properly secured to the forks or the base of the fork carriage.
    - b. The platform must be equipped with guardrails, toeboards, and a back guard.
  - c. It must have no spaces or holes larger than 1 inch.
  - d. It must have a slip-resistant platform surface. **3657(b)(5)**
- 2. The operator must be at the controls while the employees are elevated. **3657(e)**
- 3. The operator must follow the operating rules as per **3657(j)** for elevating employees. **3657(j)**
- 4. Employees shall not sit, climb, or stand on platform guardrails or use planks, ladders, or other devices to gain elevation. **3657(i)**

*Note: When guardrails are not possible due to clearance limits/nature of the work, personal fall protection is required. 3657(b)*
- 5. Where boom type forklifts are used to elevate employees, personal fall restraint or positioning devices must be used in addition to the above requirements.
- E. All forklifts must have parking brakes. **3661(b)**
- F. All forklifts must have an operable horn. **3661(c)**
- G. When the operator is exposed to the possibility of falling objects, the forklift must be equipped with overhead protection (canopy). **3657(d)**
- H. When provided by the industrial truck manufacturer, an operator restraint system such as a seat belt shall be used. **3650(t)**
- I. Seat belt assemblies shall be provided and used on all equipment where rollover protection is installed. **3653(a)**
- J. The employer must post and enforce a set of operating rules that includes, but not limited to the following: **3650(t)**
  1. Only trained and authorized drivers may operate forklifts.
  2. Stunt driving and horseplay are prohibited.
  3. Employees must not ride on the forks.
  4. Employees must never be permitted under the forks (unless forks are blocked).
  5. Employees must never place any part of their bodies outside the running lines of an industrial truck or between mast uprights.
  6. The driver must inspect the vehicle once during a shift.

## Forms, Falsework, and Vertical Shoring

By definition, concrete forms are considered falsework. Falsework, however, also includes support systems for forms, newly completed floors, bridge spans, etc., that provide support until appropriate curing or stressing processes have been completed.

See below for selected SOs:

### A. Design of falsework

1. Concrete formwork and falsework must be designed, supported, and braced to safely withstand the intended load. **1717(a)(1)**
2. Falsework design, detailed calculations, and drawings must be signed and approved by an engineer (Ca PE) if the falsework height (sill to soffit) exceeds 14 ft., if the individual horizontal span length exceeds 16 ft., or if vehicle or railroad traffic goes through the falsework. **1717(b)(1)(A), (B)**

*Note: For other falsework, approval may be provided by a manufacturer's representative or a licensed contractor's qualified representative. **1717(b)(2)(B), and (C)***

3. Falsework plans must be available at the job site. **1717(b)(3)**
4. Minimum design loads are as follows: **1717(a)(2)**
  - a. Total combined live and dead load: 100 psf.
  - b. Live load and formwork: 20 psf.
5. Additional loads must be considered in the design. **1717(a)**

### B. Erection of falsework

1. Falsework must be erected on a stable, level, compacted base and supported by adequate pads, plates, or sills. **1717(b)(4)**
2. Shore clamps (metal) must be installed in accordance with manufacturer's instructions. **1717(d)(2)**

### C. Inspection

1. Before pouring concrete on falsework requiring design approval, an engineer (Ca PE) or the engineer's

7. The operator must look in the direction of travel and must not move the vehicle until all persons are clear of the vehicle.
  8. Forks must be carried as low as possible.
  9. The operator must lower the forks, shut off the engine, and set the brakes (or block the wheels) before leaving the forklift unattended (when the operator is out of sight of the vehicle or 25 ft. away from it).
  10. Trucks must be blocked and brakes must be set before a forklift is driven onto the truck bed.
  11. Extreme care must be taken when tilting elevated loads.
  12. The forklift must have operable brakes capable of safely stopping it when fully loaded.
- K. An employee must be properly trained (as certified by the employer) before operating a forklift. **3668(a)**
1. An evaluation of the operator's performance must be conducted at least once every three years. **3668(d)**
  2. Refresher training in relevant topics must be provided to the operator when: **3668(d)(1)**
    - a. The operator is observed operating the vehicle in an unsafe manner.
    - b. The operator has been involved in an accident or near-miss incident.
    - c. The operator's evaluation reveals that he or she is not operating the truck safely.
    - d. The operator is assigned to drive a different type of truck.
    - e. Changes in workplace conditions could affect safe operation of the truck.
- L. The use, care, and maintenance of slings used in lifting suspended loads must meet the requirements of **Article 101** of the GSO. **3650(u)**
- M. Loads must be so balanced, braced, or secured as to prevent tipping and falling. Only stable or safely arranged loads shall be handled. **3650(l)**



representative must inspect for and certify compliance with plans. **1717(c)(1)**

*Note: For other falsework, the inspection and certification may be provided by a manufacturer's representative or a licensed contractor's qualified representative. **1717(c)(2)(B), and (C)***

2. A copy of the inspection certification must be available at the job site. **1717(c)(3)**

D. Access to forms and falsework

1. Joists (5 1/2 inch wide) at not more than 36 inches o.c. may be used as walkways while forms are placed. **1717(d)(3)**

2. A plank (12 inches wide) may be used as a walkway while joists are placed. **1717(d)(5)**

E. Fall protection

Periphery rails are required as soon as supporting members are in place. **1717(d)(4)**

*Note: The area under formwork is a restricted area and must be posted with perimeter warning signs. **1717(d)(6)(A)***

## Guardrails

Guardrails must be installed at the open sides of all work surfaces that are 7 1/2 ft. or higher above the ground, floor, or level underneath, or workers must be protected by other fall protection or, if justified, by a valid fall protection plan. **1621(a)**

A. Guardrail specifications. **1620**

1. Railings shall be constructed of wood or in an equally substantial manner from other materials, and shall consist of the following:
  - a. A wooden top rail that is 42 inches to 45 inches high and that measures 2 inches x 4 inches or larger.
  - b. A mid-rail shall measure at least 1 inch x 6 inches and shall be placed halfway between the top rail and the floor when there is no wall or the parapet wall is less than 21 inches high.
  - c. Screens, mesh, intermediate vertical members, solid panels, or equivalent members may be used in lieu of a mid-rail subject to the following:

- (1) Screens and mesh shall extend from the top rail to the floor and along the entire opening between top rail supports.
- (2) The gap between the intermediate vertical members shall not be greater than 19 inches.
- (3) Other intermediate members such as solid panels shall not have gaps more than 19 inches.

d. Wood posts shall be not less than 2 inches by 4 inches in cross section, spaced at 8 ft. or closer intervals.

*Note: Use only "Selected Lumber"— free from damage that affects its strength for wood railings. Steel banding and plastic banding shall not be used as top rails or mid-rails.*

2. All railings and components shall be capable of withstanding a force of at least 200 lbs. applied to the top rail within 2 inches of the top edge, in any outward or downward direction, at any point along the top edge.
3. Mid-rails, screens, mesh, intermediate vertical members, solid panels, and equivalent members shall be capable of withstanding a force of at least 150 lbs. applied in any downward or outward direction at any point.
4. The top rail or mid-rail on scaffolding platforms may be substituted by the X-braces (see the Scaffolds section in this guide). **1644(a)(6)**
5. The ends of the rails shall not overhang the terminal posts, except where such overhang does not constitute a projection hazard. **1620(f)**
6. Railings shall be so surfaced as to prevent injury to an employee from punctures or lacerations and to prevent snagging of clothing. **1620(g)**

B. Guardrail applications

1. Floor and roof openings: **1632(b)(3)**
  - a. Floor, roof, and skylight openings in any work surface must be guarded by railings and toeboards or by covers.
  - b. The cover must be able to support 400 lbs. or twice the weight of the employees, equipment, and material, and be securely fastened.
  - c. Covers must bear a sign with minimum 1-inch letters stating—**OPENING—DO NOT REMOVE.**

d. Employees within 6 ft. of any skylight shall be protected from falling through the skylight opening by any one of the following methods:

- (1) Guardrails. **3209**
- (2) Skylight screens. **3212(e)**
  - Installed above the skylight. **3212(e)(1)**.
  - Installed below the skylight. **3212(e)(2)**.
- (3) Personal fall protection system. **1670**
- (4) Covers installed over the skylights, including skylights themselves that meet **3212(b)** and **1632**.
- (5) Skylight nets. **3212(e)(6)**
- (6) Fall protection plan. **1671.1**

*Exception: When the work is of short duration and exposure is limited. **3212(e)***

- e. Access to surfaces glazed with transparent or translucent materials are not permitted unless an engineer certifies that the surface will sustain all anticipated loads. **3212(f)**
2. Wall openings: Wall openings must be guarded if there is a drop of more than 4 ft. and the bottom of the opening is less than 3 ft. above the working surface. **1632(j)**
  3. Elevators: Guardrails are required for elevator shaft openings that are not enclosed or do not have cages. **1633**
  4. Falsework: Guardrails are required as soon as falsework-supporting members are in place. **1717(d)(4)**
  5. Demolition: Wall openings must be protected by guardrails during demolition except on the floor being demolished and on the ground floor. **1735(k)**
  6. Roofing operations: Provisions must be made during roofing operations to prevent workers from falling off roofs 20 ft. or higher. **1730(b)(1)**
  7. Skeleton steel building: A single  $\frac{3}{8}$ -inch wire rope, in lieu of standard railing, may be used to guard openings and exposed edges of temporary floors or planking in skeleton steel buildings. The  $\frac{3}{8}$ -inch wire rope must have a breaking strength of 13,500 lbs. (min.) and be placed at 42 inches to 45 inches above the finished floor. **1710(l)(3)**

## Hazard Communication Program (HAZCOM)

A hazardous chemical is any chemical that is classified as a physical hazard or a health hazard, a simple asphyxiant, combustible dust, pyrophoric gas, a hazard not otherwise classified, or is included in the List of Hazardous Substances prepared by the Director pursuant to Labor Code section 6382. These chemicals may include solvents, paints, thinners, cleaning agents, fresh concrete, and fuels. Employers whose employees may be exposed to hazardous chemicals are required to have a HAZCOM program. **5194**

- A. Employers must develop, implement, and maintain at the workplace a written HAZCOM program that includes information on labels, warning, safety data sheets (SDSs), training requirements, and other relevant information as per **5194**.
- B. The program must include the following:
  1. A list of the hazardous chemicals that are used or stored in the workplace. It must include any chemicals listed in the following:
    - a. The Hazardous Substances List. **339**
    - b. The Code of Federal Regulations (CFR, Part 1910, Subpart Z).
    - c. Threshold Limit Values for Chemical Substances in the Work Environment (ACGIH) latest edition.
    - d. Chemicals identified and regulated under Title 8, **Article 107**, Dusts, Fumes, Mists, Vapors and Gases, and **Article 109**, Hazardous Substances and Processes. **5194(d)(3)**
    - e. T22 CCR 12000 (Proposition 65).
  2. Labels and other forms of warning on containers of hazardous chemicals.
  3. Readily accessible SDSs.
  4. Procedures for safe handling, use, storage, disposal, and clean up to protect employees.

*Note: All hazardous liquids capable of physical injury on skin contact must be covered, insulated, or otherwise guarded against inadvertent contact. When the nature of the work makes covering or guarding impracticable,*

*employer must provide personal protective equipment.*  
**3302**

5. Training on the hazardous chemicals that employees are or could be exposed to in the workplace.
  6. The methods the employer will use to inform employees of the hazards of non-routine tasks and the hazards associated with chemicals contained in unlabeled pipes in their work areas. **5194(e)(1)(B)**
  7. Clear and reasonable warnings for exposures to hazardous chemicals shall be displayed in the workplace using warning signs and labels or provided through information and training. **5194. Appendix G #12601(c)**
  8. For each chemical included in the HAZCOM program, the information provided on the warning signs and labels must include all of the required texts as per the T8 CCR requirements for that specific chemical.
  9. A plan for managing multi-employer work-site issues including the methods used to inform other work-related employers.
  10. A plan for periodically (e.g., annually) evaluating the effectiveness of the program and for updating the program.
- C. The HAZCOM program must be available on request to employees, their representatives, and Cal/OSHA.

*Note: The Guide to the California Hazard Communication Regulation is available free of charge from Cal/OSHA at: [www.dir.ca.gov/dosh/dosh\\_publications/hazcom.pdf](http://www.dir.ca.gov/dosh/dosh_publications/hazcom.pdf).*

- D. Employers must make sure that:
1. Each container of hazardous chemicals in the workplace is labeled, tagged, or marked. Information can be provided using labels on shipped containers or with required information such as product identifiers, pictograms, precautionary and hazard statements, first aid information, and signal words. **5194(f)(6)**
  2. The labels on incoming containers of hazardous chemical substances are not removed or defaced.
- E. Employers are required to: **5194(g)**
1. Have an SDS for each hazardous chemical they use.
  2. Use SDSs that are consistent with the Globally Harmonized System (GHS).

3. Make the SDSs readily accessible during each work shift to employees when they are in their work areas.
- F. Employers must provide all required information and training as per **5194(h)** to their employees. The training includes:
1. Labeling, pictograms, symbols, etc.
  2. SDSs, including physical and health hazards.
  3. Chemical-specific information (must always be available through labels and SDSs).
  4. Location of hazardous chemicals.
  5. Where the written HAZCOM program is kept.
  6. Detection of presence or release of hazardous chemicals.
  7. PPE and appropriate work practices.
  8. Emergency and first aid procedures.

## Heat Illness Prevention

Heat illness can be one or more medical conditions including heat rash, heat cramps, fainting, heat exhaustion, and heat stroke. Heat illness may be mild initially but can become severe or fatal if the body temperature continues to rise. Supervisors, foremen, and employees should look continuously for signs and symptoms of heat illness in themselves and fellow workers.

To help employers develop, implement, and monitor their heat illness prevention procedures, Cal/OSHA has provided a number of materials on heat illness prevention including:

- Educational resources including Employer's Training Kit ([www.dir.ca.gov/DOSH/HeatIllnessInfo.html](http://www.dir.ca.gov/DOSH/HeatIllnessInfo.html))
- eTool ([www.dir.ca.gov/dosh/etools/08-006/index.htm](http://www.dir.ca.gov/dosh/etools/08-006/index.htm))
- Employer's Sample Procedures ([www.dir.ca.gov/dosh/dosh\\_publications/HIP-sample-procedures.doc](http://www.dir.ca.gov/dosh/dosh_publications/HIP-sample-procedures.doc))
- "Protect Yourself from Heat Illness" publication ([www.dir.ca.gov/dosh/dosh\\_publications/HeatIllnessEmployeeEngSpan.pdf](http://www.dir.ca.gov/dosh/dosh_publications/HeatIllnessEmployeeEngSpan.pdf))

Signs and symptoms of heat illness may include:

#### Heat Rash (Prickly Heat)—General Symptoms:

- Can cover large parts of the body
- Looks like a red cluster of pimples or small blisters
- Often on the neck, chest, groin, under the breasts, or in elbow creases
- Feels uncomfortable, can disrupt sleep and work performance
- Complicated by infections

#### Heat Cramps—General Symptom:

- Painful muscle spasms in the stomach, arms, legs, and other body parts (may occur after work or at night)

#### Fainting—General Symptoms:

- Sudden dizziness, light-headedness
- Unconsciousness

#### Notes:

»Provide first aid immediately

»Never give liquids to an unconscious person

#### Heat Exhaustion—General Symptoms:

- Heavy sweating, painful muscle cramps, extreme weakness and/or fatigue
- Nausea, vomiting, dizziness, headache
- Body temperature normal or slightly high
- Fainting
- Pulse fast and weak
- Breathing fast and shallow
- Clammy, pale, cool, and/or moist skin

*Note: Heat exhaustion can occur because of high core body temperature even when an individual is well hydrated.*

#### Heat Stroke—General Symptoms:

- No sweating; the body cannot release heat or cool down
- Mental confusion, delirium, convulsions, dizziness

- Hot and dry skin (e.g., red, bluish, or mottled)
- Muscles may twitch uncontrollably
- Pulse can be rapid and weak
- Throbbing headache, shallow breathing, seizures/fits
- Unconsciousness and coma
- Body temperature may range from 102–104°F or higher within 10–15 minutes

*Note: A heat stroke victim may die within 30 to 60 minutes unless treated properly, and survivors may have some degree of permanent neurological impairment.*

Requirements and guidance for heat illness prevention in the workplace:

- A. All employers who have employees working in outdoor places of employment must have a written heat illness prevention plan and implement effective procedures for the prevention of heat illness.
- B. The plan must be employer-specific and be available on site or immediately available on request of the employee or the Division.
- C. Heat illness prevention plan, at a minimum, must include: **3395(i)**
  1. Procedures for providing sufficient water
  2. Procedures for providing access to shade
  3. High-heat procedures
  4. Emergency response procedures
  5. Acclimatization methods and procedures
- D. The plan shall be in writing in both English and the language understood by the majority of the employees.
- E. Procedures for providing sufficient water. **3395(c)**
  1. Sufficient amounts of fresh, pure, and suitably cool potable water shall be available at all times.
  2. Provide at least one quart per employee per hour for the entire shift.
  3. If individual water containers are provided, the containers must be clean, and a source of potable water must be readily available.

4. Water from unpermitted/unlicensed or non-tested water sources must not be used.

*Notes:*

*Permits for public water systems are granted by the California State Water Resources Control Board ([www.waterboards.ca.gov/drinking\\_water/certlic/drinkingwater/Permits.shtml](http://www.waterboards.ca.gov/drinking_water/certlic/drinkingwater/Permits.shtml))*

5. If hoses or connections are used, they must meet the requirements for potable drinking water system as per California Health and Safety Code section 114205–114242.
6. During hot weather, the water must be cooler than the ambient temperature.

*Note: Do not have water so cool as to cause discomfort.*

7. Place water as close as practicable to where employees are working. For example, on a multi-story construction site, place water in a safely accessible location on every floor where employees are working.
  8. Remind workers to drink water often and not to wait until they are thirsty to drink.
  9. Provide water at no cost to the workers.
- F. Procedures for providing access to shade. **3395(d)**

Provide shade to employees during breaks and preventative cool down rest periods by taking following measures.

**1. When outdoor temperature is 80°F or less:**

- a. Have shade available and provide shade or timely access to shade upon request.
- b. It helps to have the shade erected if the weather is hot enough that the shade can help employees to cool off.

**2. When outdoor temperature exceeds 80°F:**

- a. Have one or more areas with shade at all times while employees are present. If no other shade is readily available, erect shade structures immediately.
  - b. It is a good idea to set up the shade in advance if at 5:00 p.m. the night before, the temperature is predicted to exceed 80°F.
3. Perform frequent checks of the temperature at the worksite because you need to set up the shade immediately if the temperature exceeds 80°F. It is a good

idea to check the temperature hourly.

4. Place the shade structure as close as practicable to the areas where employees are working.
5. Shade must be either open to the air or provided with ventilation or cooling, and must be easy for employees to reach.
6. Permit employees to access shade at all times.
7. Provide enough shade to accommodate all employees:
  - a. who are on recovery and rest period breaks, and
  - b. who choose to remain in areas designated for recovery and rest periods during their meal periods.
8. Erect additional structures on an as-needed basis.
9. Encourage employees to take a cool-down rest in the shade when they feel the need to do so to protect themselves from overheating.
10. Have water available in the rest area so that employees are encouraged to drink more water.
11. When it is not possible to erect a shade structure, you may provide alternative cooling measures that offer equivalent protection. **Exceptions to 3395(d)(1) and (d)(2)**
12. Monitor the employee on cool-down rest and ask if he or she is experiencing any symptoms of heat illness, including simple fatigue.
13. If an employee exhibits or complains of any sign or symptom of heat illness, initiate first-aid procedures without delay.
14. Encourage the employee on cool-down rest to remain in the shade for 5 or more minutes as needed.

G. High-heat procedures: **3395(e)**

1. Implement high-heat procedures when the temperature equals or exceeds 95°F.
2. Train all employees to recognize the signs and symptoms of heat illness and allow them to call for emergency medical services when necessary.
3. Train all employees to stay in contact, observe each other, and immediately report any signs/symptoms of heat illness.

4. Observe and monitor employees for alertness and signs or symptoms of heat illness by implementing one or more of the following:
  - a. Supervisor or designee observation of 20 or fewer employees
  - b. Mandatory buddy system
  - c. Regular communication with sole employee using radio or cellular phone
  - d. Other effective means of observation
    - (1) Contact employees regularly.
    - (2) Designate one or more employees on each worksite as authorized to call for emergency medical services.
5. Remind employees throughout the work shift to drink plenty of water.
6. Provide close supervision to new employees as they may have less or no acclimatization.
7. Conduct pre-shift meetings to review the high-heat procedures and to remind employees to drink plenty of water and take a cool-down rest when necessary.

H. Emergency response procedures: **3395(f)**

Employers are required to implement effective emergency response procedures in the workplace. Requirements and guidance include the following:

1. Maintain effective communication by voice, observation, or electronic means.
2. Take immediate action if any signs or symptoms of heat illness in any employee is observed or reported.
3. Implement emergency response procedures if the signs or symptoms indicate severe heat illness.
4. Do not leave the employee exhibiting signs or symptoms of heat illness alone or send them home without offering onsite first aid and/or providing emergency medical services.
5. Contact emergency medical services and, if necessary, transport employees to a place where they can be reached by an emergency medical provider.
6. In the event of an emergency, make sure that clear

and precise directions to the worksite are provided to emergency responders.

7. If you have mobile crews, provide the emergency medical provider a map of the crew's location or detailed direction.

I. Acclimatization methods and procedures **3395(g)**

1. Make sure that all employees are observed by a supervisor or designee during a heat wave.

*Note: A "heat wave" means any day in which the predicted high temperature for the day will be at least 80°F and at least 10°F higher than the average daily high temperature in the preceding 5 days.*

2. Have a supervisor or designee closely observe any employee who has been newly assigned to a high heat area for the first 14 days of the employment.
3. Be extra-vigilant in employee monitoring during heat waves and when new employees are on the job.

J. Training of employees and supervisors **3395(h)**

1. Training of employees and supervisors in your heat illness prevention plans and procedures is extremely important for the prevention of heat illness at the workplace.
2. Make sure that employees and supervisors are trained before any anticipated exposure to the risk of heat illness.
3. Provide training when an employee is hired.
4. Provide refresher training as needed.

*Note: Training that is given close in time to the hot season is more effective than training given during colder seasons without follow-up refresher training.*

5. Cover general and site/work-specific topics in the training including:
  - All procedures in your heat illness prevention plan, including procedures for providing water, shade and cool-down rests, high heat, emergency response, and acclimatization
  - The concept, importance, and methods of acclimatization
  - The different types of heat illness and the common signs and symptoms of heat illness
  - Appropriate first aid and/or emergency response for the

- different types of heat illness, and how to access
  - Provide the training in a language the employees understand
  - Ensure that the work procedures are consistent with the information provided in the training
  - Maintain records of the training
- K. Have a suitable number of trained persons to render first aid. Typical first aid methods for heat exhaustion and heat stroke:
1. Give first aid for heat exhaustion, lay the person down flat in a cool environment, loosen their clothing, and give them plenty of water to drink.
  2. Give first aid for heat stroke, immediately start aggressive cooling of the person and get them to a hospital right away. Cooling can include placing cool wet towels on the trunk, arms, and legs while refreshing the cooling towels every few minutes.
- L. Ways to prevent heat illness also include:
1. Monitoring the weather forecast ahead of time and planning accordingly.
  2. Timing the heaviest workload for the coolest part of the workday.
  3. Starting work early in the morning.
  4. Providing training on heat stress including prevention, recognition, and first aid as a part of the employer's IIPP. **3203, 3400, 3439**

For more information on Heat Illness Prevention, see Cal/OSHA's Heat Illness Prevention eTool at [www.dir.ca.gov/dosh/etools/08-006/index.htm](http://www.dir.ca.gov/dosh/etools/08-006/index.htm).

## Heavy Construction Equipment

Safety requirements for heavy construction equipment are as follows:

- A. General repairs must not be made to powered equipment until workers are protected from movement of the equipment or its parts. **1595(a)**
- B. Before repairs are made, workers must comply with lock-out/

block-out requirements if applicable. **3314**

- C. Wherever mobile equipment operation encroaches on a public thoroughfare, a system of traffic controls must be used. **1598(a)**
- D. Flaggers are required at all locations where barricades and warning signs cannot control the moving traffic **1599(a)**. (See exceptions in the "California Manual on Uniform Traffic Control Devices for Streets and Highways, January 13, 2012" [the Manual], published by Caltrans.)

Flaggers shall wear high-visibility safety apparel and headwear manufactured in accordance with ANSI/ISEA standards **1599(d)**. Also, all employees (on foot) such as grade-checkers, surveyors, and others exposed to the hazard of vehicular traffic, shall wear high-visibility safety apparel in accordance with the requirements of **1598** and **1599. 1590**

- E. Jobsite vehicles must be equipped with the following:
  1. Operable service, emergency, and parking brakes. **1591(c), 1597(a)**
  2. Two operable headlights and taillights for night operation. **1597(b)**
  3. Windshield wipers and defogging equipment as required. **1597(d)**
  4. Seat belts if the vehicle has rollover protection structures. **1597(g)**
  5. Fenders or mud flaps. **1591(f), 1597(i)**
  6. Adequate seating if the vehicles are used to transport employees. **1597(f)**
  7. If an exhaust retrofit is installed on a vehicle, it shall be installed and maintained as per **1591(m)**.
- F. Vehicles and systems must be checked for proper operation at the start of each shift. **1597(j)**
- G. Rollover protection structures and seat belts must be installed for:
  1. The following equipment having a brake horsepower rating above 20. **1596(a)(1)**
    - a. Bulldozer
    - b. Front-end loader

- c. Motor grader
  - d. Scraper
  - e. Tractor (except side boom pipe laying)
  - f. Water wagon prime mover
2. The following equipment:
- a. Rollers and compactors weighing more than 5,950 lbs. **1596(a)(2)**  
*Exceptions: See 1596(a)(2)(B)*
  - b. Sheepsfoot-type rollers and compactors. **1596(a)(2)(A)**
  - c. Crawler tractor. **3666**
- H. Haulage and earth-moving equipment safety requirements are as follows:
1. Every vehicle having a body capacity of 2.5 cu. yds. or more must be equipped with an automatic backup alarm that sounds immediately on backing. **1592(a)**
  2. All other vehicles operating when rear vision is blocked must be equipped with an automatic backup alarm or its equivalent. **1592(b)**
  3. All vehicles must be equipped with a manually operated warning device. **1592(c)**
  4. Haulage vehicles in operation must be under operator control and must be kept in gear when descending grades. **1593(b)**
  5. The brakes on a haulage vehicle must meet the criteria specified by the CSOs. **1591(c)**
  6. The control devices on a haulage vehicle must be inspected at the beginning of each shift. **1593(d)**
  7. Exposed scissor points on front-end loaders must be guarded. **1593(i)**
  8. Engines must be stopped during refueling. **1594(a)**
  9. Lights are required for night operation. **1591(g)**
  10. Vehicles loaded by cranes, shovels, loaders, and similar devices must have an adequate cab or canopy for operator protection. **1591(e)**
  11. Dust control is required when dust seriously limits visibility. **1590(b)**

12. In dusty operations, equipment operators shall use adequate respiratory protection. **1590(b)**
  13. Loads on vehicles must be secured from displacement. **1593(f)**
  14. If an exhaust retrofit is installed, install and maintain as per **1591(m)**.
- I. Safety requirements for industrial trucks and tractors include:
1. Posting and enforcing by employers using industrial trucks or industrial tow tractors a set of operating rules including the appropriate rules listed in GISO **3650(t)**, **3664(a)**.
  2. Providing operating instructions at the time of initial assignment and at least annually thereafter. **3664(b)**
  3. Using the locking device where the dump body of a truck is raised for work. **1595(b)**
  4. Performing repair work only when there is no possibility of sudden movements or operation of the equipment or its parts. Keeping all controls in a neutral position, with the engine(s) stopped and brakes set, unless work being performed requires otherwise. **1595(a)**

## Hot Pipes and Hot Surfaces

- A. Cover all hot pipes and hot surfaces with a thermal insulating material or keep them guarded against contact when they are at 140°F (60°C) or higher and located within:
- 7 ft. measured vertically from floor or working level or
  - 15 inches measured horizontally from stairways, ramps or fixed ladders. **3308**
- Note: This order does not apply to operations where the nature of the work or the size of the parts makes guarding or insulating impracticable. **3308***
- B. Check for leaks from pipelines and ensure the leaks are stopped before working near them. The energy within the piping system must be controlled to prevent an uncontrolled release that could cause injury. **3329**



## Housekeeping/Site Cleaning

Housekeeping is a term used to describe the cleaning of the work site and surrounding areas of construction project-related debris. The term also refers to the managing and storing of materials that are used on the project. Listed below are the general requirements for housekeeping to which all work sites are subject.

It is important to remember that work sites subject to specific SOs may have additional housekeeping requirements with which to comply.

- A. Work surfaces, passageways, and stairs shall be kept reasonably clear of scrap lumber and debris. **1513(a)**
- B. Ground areas within 6 ft. of buildings under construction shall be kept reasonably free of irregularities. **1513(b)**
- C. Storage areas and walkways on construction sites shall be kept reasonably free of dangerous depressions, obstructions, and debris. **1513(c)**
- D. Piled or stacked material shall be placed in stable stacks to prevent it from falling, slipping, or collapsing. **1549(a)**
- E. Material on balconies or in other similar elevated locations on the exteriors of buildings under construction shall be placed, secured, or positively barricaded in order to prevent the material from falling. **1549(h)**

## Injury and Illness Prevention Program

An Injury and Illness Prevention Program (IIPP) is required at all work sites. The program is considered effective if it satisfies the regulatory requirements of **3203** and helps the employer and the employee to identify and control the hazards specific to their work site. Following is a summary of the regulatory requirements.

- A. The IIPP must be in writing and must include the following elements: **1509(a)**, **3203(a)**
  1. The employer's assignment of responsibilities. **3203(a)(1)**
  2. A system for ensuring employee compliance with safe work practices. **3203(a)(2)**
  3. A system for two-way communication between employers and employees about safety issues. **3203(a)(3)**

4. Scheduled inspections and an evaluation system to identify hazards. **3203(a)(4)**
5. An accident investigation process. **3203(a)(5)**
6. Procedures for correcting unsafe and unhealthy conditions. **3203(a)(6)**
7. Safety and health training. **3203(a)(7)**
8. Employee access to the written IIPP. **3203(a)(8)**
9. Recordkeeping. **3203(b)**

### B. Other IIPP requirements for construction are as follows:

1. Employers must adopt and post a Code of Safe Practices at each job site. Plate A-3 in Appendix A of the CSOs illustrates a general format. **1509(b)**, **(c)**
2. Periodic meetings of supervisors must be held to discuss the safety program and accidents that have occurred. **1509(d)**, **3203**
3. Supervisors must conduct tailgate or toolbox safety meetings at least every 10 working days; however, weekly meetings are recommended. **1509(e)**

### C. Required safety training for employees includes the following:

1. New workers shall be instructed in safe work practices, job hazards, and safety precautions and shall be required to read the Code of Safe Practices. **1510(a)**
2. The employer shall permit only qualified or experienced employees to operate equipment or machinery. **1510(b)**
3. Workers shall be instructed in the following:
  - a. The recognition of job site-specific hazards
  - b. Procedures for protecting themselves
  - c. First aid procedures in the event of injury. **1510(c)**

### D. General safety requirements are as follows:

1. No worker shall be required or permitted to work in an unsafe workplace. **1511(a)**
2. Before starting work, the employer shall survey the job site for hazards and use necessary safeguards to ensure that work is performed safely. **1511(b)**

### E. Specific requirements are as follows:

If an employer is subject to specific safety orders, the

requirements of these SOs must be considered when developing the employer’s IIPP. These SOs may include specific procedures or processes as well as requirements for reporting, training, exposure limits, personal protection, and registration and certification.

- F. Employees have numerous rights under the IIPP, including the following: **3203(a)**
  - 1. The right to work in a safe and healthful workplace
  - 2. The right to inform the employer of workplace hazards without fear of reprisal
  - 3. The right to receive training that is readily understandable
  - 4. The right to access and receive a copy of the written IIPP
- G. To ensure the effectiveness of the IIPP:
  - 1. Supervisors should be qualified in safety procedures and held accountable.
  - 2. The effectiveness of the safety program should be monitored.
- H. Create your written IIPP using the following resources:
  - 1. IIPP publications ([www.dir.ca.gov/dosh/PubOrder.asp#IIPP](http://www.dir.ca.gov/dosh/PubOrder.asp#IIPP)) on Cal/OSHA’s website are provided to help you develop or improve your IIPP. To develop a written IIPP customized to your workplace, answer the IIPP questions in the IIPP Builder or use the applicable model program.
  - 2. “The Guide to Developing Your Workplace Injury and Illness Prevention Program” is available online at [www.dir.ca.gov/dosh/dosh\\_publications/iipp.pdf](http://www.dir.ca.gov/dosh/dosh_publications/iipp.pdf).

## Ladders

Falls are the most common cause of worker injury associated with ladder use. Falls are mostly caused by the (1) use of faulty ladders; (2) improper set-up of a ladder; or (3) incorrect use of ladders.

Except where either permanent or temporary stairways or suitable ramps or runways are provided, ladders shall be used to give safe access to all elevations. **1675(a)**

- A. General requirements for ladders:

- 1. Portable ladders shall comply with T8 CCR **3276, 1675(b)**.
- 2. Design and construction of portable ladders shall comply with T8 CCR **3276(c)**.
- 3. Fixed ladders shall comply with T8 CCR **3277** and **3278, 1675(c)**.
- 4. Wood parts of fixed ladders shall meet the requirements of T8 CCR **3276(c), 3277(c)(5)**.
- 5. Extension ladders shall comply with **3276(e)(16)**.
- 6. Portable metal ladders shall comply with **3276**.
- 7. Portable wood ladders shall comply with **3276**.
- 8. Portable reinforced plastic ladders shall comply with **3276(c), (e)**.
- 9. Single-rail ladders shall not be used.
- B. Portable ladders are generally designed for one-person use to meet the requirements of the person, the task, and the environment. When selecting a ladder for use, consider the ladder length, height, the working load, the duty rating, worker position, and how often the ladder is used. **3276(d)(1)(B)**
- C. Double-cleat ladders are required for two-way traffic or when 25 or more employees are using a ladder. Double-cleat ladders shall not exceed 24 ft. in length. **1629(c)**
- D. Maximum lengths of portable ladders shall not exceed the following: **3276(e)(16)(D)**

| Ladder Type                                       | Maximum Length (Feet) |
|---|-----------------------|
| Step ladder                                       | 20                    |
| Two-section extension ladder (wood)               | 60                    |
| Two-section extension ladder (metal)              | 48                    |
| Three-section extension ladder (metal)            | 60                    |
| Two-section extension ladder (reinforced plastic) | 72                    |
| Painter’s step ladder                             | 12                    |
| Cleat ladder                                      | 30                    |
| Single ladder                                     | 30                    |

- E. Minimum overlap in two-section portable extension ladders shall not be less than the following: **3276(e)(16)(E)**

| Ladder Size (Feet)              | Minimum Overlap (Inches) |
|---------------------------------|--------------------------|
| Up to and including 32          | 36                       |
| Over 32, up to and including 36 | 46                       |
| Over 36, up to and including 48 | 58                       |
| Over 48, up to and including 60 | 70                       |

- F. Portable ladders shall be used according to the following duty classifications: **3276(d)(2)**

| Duty Rating      | Ladder Type | Working Load (Pounds) |
|------------------|-------------|-----------------------|
| Special Duty     | IAA         | 375                   |
| Extra Heavy-Duty | IA          | 300                   |
| Heavy-Duty       | I           | 250                   |
| Medium-Duty      | II          | 225                   |
| Light-Duty       | III         | 200                   |

- G. All portable ladders used in outdoor advertising structures shall be at least Type I, Type IA or Type IAA as designed and constructed in accordance with T8 CCR **3276, 3413(a)**.

- H. Job-built ladders must meet the following requirements:

1. Job-built ladders must safely support the intended load. **1676(a)**
2. Cleats must be made from clear, straight-grained lumber and must be uniformly spaced 12 inches apart vertically. **1676(c)**
3. Cleats must be nailed at each end with three 10d nails or the equivalent. **1676(j)**
4. Cleats must be blocked or notched into the side rails. **1676(j)**
5. The width of single-cleat ladders shall be 15 inches to 20 inches. **1676(f)**
6. Rails must be made from select Douglas Fir without knots (or the equivalent). **1676(b)**
7. Rail splicing is permitted only when there is no loss of strength to the rail. **1676(b)**
8. Single-cleat ladders must not exceed 30 ft. in length. **1676(e)**

9. Double-cleat ladders must not exceed 24 ft. in length. **1676(d)**

- I. Portable Ladders

1. Inspection and maintenance requirements are below:

- a. Ladders shall be inspected by a Qualified Person for visible defects frequently and after any occurrence that could affect their safe use. **3276(e)(2)**
- b. Ladders shall be maintained in good condition at all times. **3276(e)(2)**
- c. Metal ladders shall not be exposed to acid or alkali materials that are capable of corroding the ladder and reducing the ladder's strength, unless recommended otherwise. **3276(e)(1)**
- d. Remove ladders that have developed defects, such as broken or missing steps, rungs, cleats, safety feet, side rails, or other defects from service, and tag or mark them "Dangerous, Do Not Use." **3276(e)(3)**
- e. All ladders shall be free of oil, grease, or slippery materials. Wood ladders shall not be painted with other than a transparent material. **3276(e)**

2. Prohibited uses of portable ladders are given below:

- a. Ladders shall not be used as a brace, skid, guy or gin pole, gang-way, or for uses they were not intended for, unless recommended by the manufacturer. **3276(e)(16)**
- b. Do not place planks on the top cap. **3276(e)(16)(B)**
- c. Step ladders shall not be used as single ladders or in the partially closed position. **3276(e)(16)(C)**

3. To safely use portable ladders, employees must also follow the requirements noted below:

- a. All portable ladders used for window washing shall be equipped with nonslip devices. Middle and top sections shall not be used as bottom sections unless equipped with nonslip bases. **3287(b)(2)**
- b. Portable ladders shall not be overloaded when used. **3276(e)(6)**
- c. The base of ladders shall be placed on a secure and level footing. Ladders shall not be placed on unstable bases. **3276(e)(7)**
- d. Ladders shall not be used on ice, snow, or slippery

- surfaces unless slippage is prevented. **3276(e)(7)**
- e. The top of a non-self-supporting ladder shall be placed with two rails supported equally, unless a single support attachment is provided and used. **3276(e)(8)**
- f. Non-self-supporting ladders shall, where possible, be used so that the horizontal distance from the top support to the foot of the ladder is one-quarter of the working length of the ladder. **3276(e)(9)**
- g. The ladder shall be so placed as to prevent slipping, or it shall be tied, blocked, held, or otherwise secured to prevent slipping. **3276(e)(9)**
- h. Ladders shall not be used in a horizontal position as platforms, runways, or scaffolds unless designed for such use. **3276(e)(9)**
- i. When two or more separate ladders are used to reach an elevated work area, the ladders shall be offset with a platform or landing between the ladders (see exceptions). **3276(e)(10)**
- j. Extend ladder side rails to at least 3 ft. above the landing unless handholds are provided. **1629(c)(3)**, **3276(e)(11)**
- k. Do not tie ladders together to provide longer sections unless the ladders are designed for such use and equipped with the necessary hardware fittings. **3276(e)(12)**
- l. Extension ladders shall be erected so that the top section is above and resting on the bottom section with the rung locks engaged. **3276(e)(13)**
- m. Do not place ladders in passageways, doorways, driveways, or any location where they may be displaced unless protected by barricades or guards. **3276(e)(14)**
- n. Climb or work with the body near the middle of the step or rung and do not overreach from this position. To avoid overreaching, the employee shall descend and reposition the ladder. **3276(e)(15)(A)**
- o. Employees shall be prohibited from carrying equipment or materials that prevent the safe use of ladders. **3276(e)(15)(B)**
- p. Face the ladder while climbing and descending, and maintain contact with the ladder at three-points at all times. **3276(e)(15)(C)**
- q. Do not stand and work on the top three rungs of single or extension ladders. **3276(e)(15)(D)**
- r. Employees shall not sit, kneel, step, or stand on the pail shelf, topcap, or the step below the topcap of a stepladder. **3276(e)(15)(E)**
- Exception: Employees may stand on the step below the topcap if it is located 18 inches under the topcap.*
- s. Do not use the X-bracing on the rear section of a stepladder for climbing unless the ladder is so designed and provided with steps for climbing on both front and rear sections. **3276(e)(15)(F)**
- t. Ladders shall not be moved or extended while occupied, unless designed and recommended by the manufacturer. **3276(e)(15)(G)**
- u. Portable rung ladders with reinforced rails shall be used only with the metal reinforcement on the underside. **3276(e)(17)**
- v. Non-conductive ladders shall be used in locations where the ladder or user may contact unprotected energized electrical conductors or equipment. Conductive ladders shall be legibly marked with signs reading—"CAUTION -- DO NOT USE AROUND ELECTRICAL EQUIPMENT" or equivalent. **3276(e)(18)**
- w. The area around the top and bottom of a ladder shall be kept clear. **3276(e)(19)**
- J. Fixed Ladders**
- To safely use fixed ladders, employees must also follow the requirements noted below:
1. Do not carry equipment or materials that prevent the safe use of ladders. **3278(a)**
  2. Fixed ladders shall be inspected before use. Any ladder determined to be unsafe shall not be used. **1511(b)**
  3. Face the ladder when ascending and descending. **3278(a)**
  4. Always use both hands when climbing up or down the ladder. **3278(a)**
  5. Do not use single-rail ladders. **3278(a)**
- K. The following are training requirements for employees using portable ladders: **3276(f)****

1. Employees shall be trained in the safe use of ladders before using them.
  2. Supervisors of employees who routinely use ladders shall also be trained in ladder safety training.
  3. The training may be provided as part of the employer's IIPP (T8 CCR **3203**).
  4. The training shall address the following topics, unless the employer demonstrates that a topic is not applicable to the workplace:
    - a. Importance of using ladders safely, including discussion of injuries due to falls from ladders. **3276(f)(1)**
    - b. Selection of ladders, including types, proper length, maximum working loads, and electrical hazards. **3276(f)(2)**
    - c. Maintenance, inspection, and removal of damaged ladders from service. **3276(f)(3)**
    - d. Erecting ladders, including footing support, top support, securing, and angle of inclination. **3276(f)(4)**
    - e. Climbing and working on ladders, including user's position and points of contact with the ladder. **3276(f)(5)**
    - f. Causes of falls, including haste, sudden movement, lack of attention, footwear, and user's physical condition. **3276(f)(6)**
    - g. Prohibited uses, including climbing on cross bracing, uses other than designed, exceeding maximum lengths, and not meeting minimum overlap requirements. **3276(f)(7)**
  - L. It is a good idea to make sure that the stepladder is properly set up and that the spreader is in the locked position before use.
- C. Laser beams must never be pointed or directed at persons. **1801(g)**
  - D. Lasers must have a label indicating their maximum output. **1801(i)**
  - E. Employees who have potential exposure to direct or reflected laser light greater than 5 milliwatts shall be provided with anti-laser eye protection as specified in section **3382(e)**, **1801(c)**.
  - F. Warning signs and labels (in accordance with ANSI) must be posted in areas where lasers are used. **1801(d)**

## Lead

Occupational exposures to lead can occur in construction activities, such as plumbing system retrofits; the spraying, removal, or heating of paint that contains lead; and the welding, cutting, and grinding of lead-containing construction materials.

Occupational lead exposures can affect workers as well as family members and friends who come in contact with the "take-home" lead on the worker's clothing, hair, hands, etc. The toxic effects of lead on the human body have been well documented and include damage to the kidneys, brain, and reproductive organs that, in turn, causes the loss of kidney function, sterility, decreased fertility, and birth defects and mental retardation in offspring.

Because of the serious, and in many cases life threatening, health effects of lead, the employer must be thoroughly knowledgeable about the regulations to protect people from lead exposure before their employees engage in any work exposing them to lead. **1532.1**

- A. Cal/OSHA enforces the "Lead in Construction Safety Orders," which make employers responsible for the following: **1532.1**
  1. For each job site, the lead hazard must be assessed. **1532.1(d)(1)**
  2. Where lead is present, the following is required:
    - a. Lead dust must be controlled by HEPA vacuuming, wet cleanup, or other effective methods. **1532.1(h)**
    - b. The employer shall ensure that food, beverage, and tobacco products are not present or used in areas where employees are exposed to lead above the PEL. The employer shall provide hygiene facilities

## Laser Equipment

The primary hazard of using laser equipment is injury to the eyes. The following are selected regulatory requirements:

- A. Only qualified persons may operate laser equipment. **1801(a)**
- B. Equipment must be turned off or shielded when unattended and not in use. **1801(e)**

for changing, showering, eating, and hand washing. **1532.1(i)**

- c. Workers shall have access to labels on containers of lead and safety data sheets, and must be trained as per **5194** and **1532.1, 1532.1(l)(1)(A)**.
  - d. The employer shall implement a written compliance program to control hazardous lead exposures. **1532.1(e)**
  - e. The employer shall provide the worker with and require the use of appropriate personal protective equipment. **1532.1(f), (g)**
  - f. The employer shall ensure that all protective clothing is removed at the completion of a work shift only in change areas provided for that purpose. **1532.1(g)**
- B. The permissible exposure limits (PELs) for airborne lead are 0.05 milligrams per cubic meter of air (mg/m<sup>3</sup>) and an action level of 0.03 mg/m<sup>3</sup>, both as an 8-hour time-weighted average (TWA). **1532.1(b)(c)**
- C. Trigger tasks are certain highly hazardous tasks that carry the presumption of airborne exposure above the PEL. They require special protective measures until it is determined that worker airborne exposures to lead are below levels specified in **1532.1**.

Following are the three levels of trigger tasks (as provided in Cal/OSHA's "Lead in Construction" fact-sheet [[www.dir.ca.gov/dosh/dosh\\_publications/lead-fct-sheet\\_rev.pdf](http://www.dir.ca.gov/dosh/dosh_publications/lead-fct-sheet_rev.pdf)]) involving lead-containing materials and their associated respirator requirements: **1532.1(d)(2)**

1. Level 1 trigger tasks: Spray painting, manual demolition, manual scraping or sanding, using a heat gun, and power tool cleaning with dust collection system.
  - Minimum respirator requirement: a half-mask respirator with N100, R100, or P100 filters
2. Level 2 trigger tasks: Using lead-containing mortar; burning lead; rivet busting; cleaning power tools without a dust collection system; using dry, expendable abrasives for clean-up procedures; moving or removing an abrasive blasting enclosure.
  - Minimum respirator requirement: A full-face mask respirator with N100, R100, or P100 filters; a supplied-air hood or helmet; or a loose-fitting hood or helmet with a powered air-purifying respirator with N100,

R100, or P100 filters

3. Level 3 trigger tasks: Abrasive blasting, welding, cutting, or torch burning on structures
  - Minimum respirator requirement: A half-mask supplied-air respirator operated in a positive pressure mode
- D. Protective requirements for all trigger tasks and any other task that may cause a lead exposure above the PEL include the following:
  1. Respirators, protective equipment, and protective clothing. **1532.1(f), (g)**
  2. Clothing change areas and a shower. **1532.1(i)**
  3. Initial blood tests for lead and zinc protoporphyrin. **1532.1(j)**
  4. Basic lead hazard, respirator, and safety training. **1532.1(l)**
  5. The employer shall post the following warning signs in each regulated area or work area where an employee's exposure to lead is above the PEL. **1532.1(m)(1)(a)**

**DANGER**

**LEAD WORK AREA**

**MAY DAMAGE FERTILITY OR THE UNBORN CHILD**

**CAUSES DAMAGE TO THE CENTRAL NERVOUS SYSTEM**

**DO NOT EAT, DRINK OR SMOKE IN THIS AREA**

*Note: The above protective requirements must be enforced until worker airborne exposures are shown to be below levels specified in **1532.1**.*

- E. Blood lead monitoring is especially important for evaluating work and hygiene practices that may result in lead ingestion. Employees whose blood lead levels exceed specified limits must be removed from the work with exposure to lead at or above the action level. These workers must be provided with normal earnings, seniority, and other employee rights and benefits for 18 months or until the job from which they were removed is discontinued, whichever occurs first. Mandatory medical removal of an employee due to lead (or other regulated chemicals) must be recorded on the Log 300 with a check in the "poisoning" column. **1532.1(k)(2), 14300.9**
- F. Employer shall notify an employee whose blood lead level is at or above 40 µg/dl that medical removal protection with benefits is required when a blood lead level is at or above 50

µg/dl. **1532.1(j)(2)(D)(2)**

*Note: Many physicians are now choosing to place employees on medical removal protection at blood lead levels above 20 µg/dl, rather than 50 µg/dl. Thus, employers should target for the 20 µg/dl level as they evaluate the BLL results.*

- G. Feasible engineering and work practice controls must be implemented to maintain employee exposures to lead below the PELs.
- H. A written compliance program that details how lead exposures will be controlled is required. **1532.1(e)**
- I. On jobs at residential and public-access buildings, workers whose exposures to lead measure above the PELs and their supervisors must receive state-approved training and certification by the California Department of Health Services.
- J. Records of air monitoring, blood lead testing, and medical removal must be maintained. **1532.1(n)**
- K. Employers who conduct lead work listed in **1532.1(d)(2)** must notify the Division, in writing, at least 24 hours before the start of work. **1532.1(p)**
- L. The "LEAD-WORK PRE-JOB NOTIFICATION" form with required information is available from Cal/OSHA at [www.dir.ca.gov/DOSH/leadnotification.pdf](http://www.dir.ca.gov/DOSH/leadnotification.pdf)

## Lighting

- A. Proper illumination is important in all construction activities. Construction areas, ramps, corridors, offices, shops, storage areas, etc., shall be lighted to not less than the minimum illumination intensities in the following table while work is in progress: **1523(a)**

Table 2 | **Minimum Illumination Intensities in Foot-Candles**

| Foot Candles | Area of Operation  |
|--------------|--|
| 3            | General construction area lighting low activity  |
| 5            | Outdoor active construction areas, concrete placement, excavation and waste areas, access ways, active storage areas, loading platforms, refueling, and field maintenance areas  |
| 5            | Indoors: Warehouses, corridors, hallways, stairways, and exit-ways   |
| 10           | General construction plant and shops (e.g., batch plants, screening plants, mechanical and electrical equipment rooms, carpenter shops, rigging lofts and active storerooms, barracks or living quarters, locker or dressing rooms, mess halls, indoor toilets, and workrooms) |
| 10           | Nighttime highway construction work  |
| 30           | First aid stations, infirmaries, and offices   |

- B. Nighttime highway construction work lighting shall be provided within the work zone to illuminate the task(s) in a manner that will minimize glare to work crews and not interfere with the vision of oncoming motorists. **1523(b)**

## Lock-out/Block-out Procedures

Every year many employees are injured or lose their lives when the equipment they are repairing or maintaining is turned on by a coworker or when potential energy is released while the employee is in harm's way of the equipment. Employees shall be trained and made familiar with the safe use and maintenance of all machinery or equipment. To prevent such injuries, SOs require that a lockout/block-out procedure must be followed.

- A. For cleaning, repairing, servicing, setup, or adjusting operations the following applies: GISO **3314**
  - 1. Cleaning, servicing, or adjusting operations **3314(c)**
    - a. Machinery or equipment capable of movement shall be stopped, and the power source shall be de-energized

or disengaged.

- b. Moveable parts shall be mechanically blocked or locked out.
  - c. If the equipment must move during cleaning, servicing or adjusting operations, the employer shall provide and require the use of extension tools or other means to protect employees from injury due to the movement. Employees shall be trained on the safe use and maintenance of such tools or means. **3314(c)(1)**
2. Repair work or setup operations. **3314(d)**
    - a. Equipment that has lockable controls or that is readily adaptable to lockable controls shall be locked out or positively sealed in the off position.
    - b. For equipment not equipped with lockable controls or readily adaptable to lockable controls, positive means must be taken, such as de-energizing or disconnecting the equipment from its source of power, or other action which will effectively prevent the equipment from inadvertent movement or release of stored energy.
  3. Accident prevention signs or tags shall be placed on the controls of equipment, machines, and prime movers. **3314(c), (d)**
  4. A written hazardous energy control procedure shall be developed and used by the employer. **3314(g)**
    - a. Energy control procedure must include separate procedural steps for the safe lockout/tagout of each machine.
  5. When servicing and/or maintenance is performed by a crew, craft, department, or other group, they shall utilize a procedure which affords the employees a level of protection equivalent to that provided by the utilization of a personal lockout or tagout device. **3314(h)**
  6. Specific hazardous energy control procedures must be utilized during shift or personnel changes to ensure the continuity of lockout or tagout protection, including, but not necessarily limited to, provision for the orderly transfer of lockout or tagout device protection between off-going and oncoming employees, in order to minimize exposure to hazards from the unexpected energization or start-up of the machine or equipment, or the release of stored energy. **3314(i)**
  7. The employer is required to conduct a periodic inspection

of the energy control procedures(s) at least annually to evaluate their continued effectiveness and determine necessity for updating written procedures. **3314(j)**

8. Energy control procedures for controlling energy sources in electrical power generation installations and related equipment for communication or metering shall be in accordance with **2940.13**
  9. De-energizing procedures of transmission/distribution lines and equipment for the purpose of protecting employees shall be in accordance with section **2940.14**
- B. For heavy construction equipment repair, **1595(a)** requires that repairs must not be made until workers are protected from movement of the equipment or its parts.
  - C. An authorized person shall be responsible for the following before working on de-energized electrical equipment or systems unless the equipment is physically removed from the wiring system: **2320.4**
    1. Notifying all involved personnel. **2320.4(a)(1)**
    2. Locking the disconnecting means in the "open" position with the use of lockable devices, such as padlocks or combination locks, or disconnecting the conductor(s) or other positive methods or procedures that will effectively prevent unexpected or inadvertent energizing of a designated circuit, equipment, or appliance. **2320.4(a)(2)**

*Exception: Locking is not required under the following conditions:*

      - a. Where tagging procedures are used as specified in **2320.4(a)(3)**, and
      - b. Where the disconnecting means is accessible only to personnel instructed in these tagging procedures.
    3. Tagging the disconnecting means with suitable accident prevention tags conforming to the provisions of **2320.6, 3314(e)**, and **2320.4(a)(3)**.
    4. Effectively blocking the operation or dissipating the energy of all stored energy devices that present a hazard, such as capacitors or pneumatic, spring-loaded, and like mechanisms. **2320.4(a)(4)**
  - D. For more helpful information see:
    1. The Lock-out/Block-out Methods and Sample Procedures publication from Cal/OSHA at:



English: [www.dir.ca.gov/dosh/dosh\\_publications/lockout.pdf](http://www.dir.ca.gov/dosh/dosh_publications/lockout.pdf)

Spanish: [www.dir.ca.gov/dosh/dosh\\_publications/lockout\\_sp.pdf](http://www.dir.ca.gov/dosh/dosh_publications/lockout_sp.pdf)

Cal/OSHA's Lockout/Tagout for Employers eTool at [www.dir.ca.gov/dosh/etools/08-003/index.htm](http://www.dir.ca.gov/dosh/etools/08-003/index.htm)

## Machine Guarding

Machine guarding is required on all moving machine parts when the operation of a machine or accidental contact with the parts could injure the operator or other workers. The following are some of the major moving machine parts that must be guarded:

- Gears, sprockets, and chain drives. **4075(a)**
- Belt and pulley drives. **4070(a)**
- Belt conveyor head and tail pulleys. **3999(b)**
- Screw conveyors. **3999(a)**
- Exposed shafts and shaft ends **4050(a)**, **4051(a)**
- Collars and couplings. **4050(a)**
- Hazardous revolving or reciprocating parts. **4002(a)**

## Multi-Employer Worksites

Multi-employer work sites are work locations where more than one employer and their employees work, usually but not necessarily at the same time. Most construction sites are multi-employer work sites, and therefore more than one employer is responsible for safety at these work sites. Each employer is required to notify the other employers of hazards and to guard against exposing their own employees as well as all other employees on the site.

The four categories of employers who may be cited by Cal/OSHA for employee exposures to violative conditions are identified in **336.10** and **336.11**.

- Exposing Employer* is an employer whose employees were exposed to the violative condition at the work site regardless of whether that employer created the violative condition.
- Creating Employer* is an employer who actually created the

violative condition.

- Controlling Employer* is an employer who is responsible, by contract or through actual practice, for safety and health conditions at the work site and who has the authority to correct the violation.
- Correcting Employer* is an employer who has the responsibility to correct the violative condition.

## Personal Protective Equipment

When a hazard cannot be eliminated or controlled by engineering or administrative controls as required by Cal/OSHA regulations, workers must be protected by personal protective equipment (PPE). Employers must ensure that all required safety devices and safeguards, whether employer- or employee-provided, comply with the applicable Cal/OSHA regulations and are maintained in a safe, sanitary condition. Employers must perform hazard assessments for all jobs and select the proper PPE for those hazards. Employers also must ensure that employees have an understanding of all of the PPE-related information listed in **3380(f)(4)**. Workers must be protected by PPE as follows:

- Eye and face protection is required when there is an inherent risk of eye injury from flying particles, injurious chemicals, or harmful light rays. **3382**
- Foot protection is required for workers who are exposed to foot injury from hot, corrosive, or injurious substances; from falling objects; or from crushing or penetrating actions. Foot protection is also required for employees who work in abnormally wet locations. **3385**
- Hand protection is required for workers who are exposed to skin absorption of harmful substances, cuts or lacerations, abrasions, punctures, chemical burns, thermal burns, radioactive materials, and harmful temperature extremes. **3384, 2320.2(a)**
- Body protection is required for workers who are exposed to injurious materials. These workers must wear appropriate body protection and clothing appropriate for their work. **1522(a)**
  - Loose sleeves, ties, frills, lapels, cuffs, or other loose clothing may not be worn around machinery in which it could become entangled. **1522(b)**

2. Workers must not wear clothing saturated or impregnated with flammable liquids, corrosives, irritants, or oxidizing agents. **1522(c)**
- E. Hearing protection (HP) is required because the noise levels of many construction operations frequently exceed 90 dBA. When employees are subjected to sound levels listed in Table 3 (**5096(b)**), feasible administrative or engineering controls must be used. If these controls fail to reduce sound levels to an acceptable range, workers must wear hearing protection and be trained to properly use the HP devices.

**Table 3 | Allowable Exposure Levels to Sound**

| Sound Level (dBA) | Time Per Day (Hours) |
|-------------------|----------------------|
| 90                | 8                    |
| 95                | 4                    |
| 100               | 2                    |
| 105               | 1                    |
| 110               | 1/2                  |

- F. Head protection requirements include the following:
1. Head protection is required for employees who are exposed to flying or falling objects or to electric shocks and burns. **3381(a)**
  2. When required, the employer shall provide each employee with head protection that meets the requirements of **3381(b)**.
  3. These employees must wear approved head protection. Hair must be confined if there is a risk of injury from entanglement in moving parts, combustibles, or toxic contaminants. **3381(e)**
  4. Everyone at a construction site should wear hard hats with bills in the forward position.
- G. Respiratory protection is required when engineering or administrative controls are not feasible or adequate for limiting harmful exposure to airborne contaminants.
- In these circumstances, exposed employees must wear respirators approved by the National Institute for Occupational Safety and Health (NIOSH). **5144(a)**

For all respirator use, a written respiratory protection program must be in place, covering employee training, respirator selection, medical evaluation, fit testing, use, cleaning, sanitizing, inspection, and maintenance. **5144(a), (c)**

*Notes: The following helpful resources are available from Cal/OSHA:*

*The health and safety fact sheet “Respiratory Protection” ([www.dir.ca.gov/dosh/dosh\\_publications/respiratory-protection-fs.pdf](http://www.dir.ca.gov/dosh/dosh_publications/respiratory-protection-fs.pdf))*

*A guide titled “Respiratory Protection in the Workplace—A Guide for Employers” ([www.dir.ca.gov/dosh/dosh\\_publications/respiratory.pdf](http://www.dir.ca.gov/dosh/dosh_publications/respiratory.pdf))*

- H. Personal flotation devices are required to be worn when working over or near water. **1602**
- I. Some of the SOs require specialized personal protective equipment not mentioned here. Employers and employees should refer to the specific SOs applicable to the type of work they perform to determine additional PPE requirements (for example, the Electrical Safety Orders **2299–2874**).
- J. Work on exposed energized parts of equipment or systems is allowed when suitable personal protective equipment and safeguards (i.e., approved insulated gloves or insulated tools) are provided and used, and other conditions as listed in **2320.2(a)** are met. **2320.2**.

## Pile Driving

Regulations concerning pile driving are as follows:

- A supervised danger zone must be established around the operating hammer if employees are cutting, chipping, or welding. **1600(a)**
- A blocking device or other effective means capable of safely supporting the weight of the hammer shall be provided to secure the hammer in the leads and shall be used at all times when any employee is working under the hammer. **1600(b)**
- All pressurized lines and hoses must be secured by 1/4 inch alloy steel chain (3,250 lb. rated capacity) or wire rope of equivalent strength. **1600(c)(1)**
- When used, work platforms must meet the specific requirements of **1600(d)**.

- E. Leads shall be provided with a continuous ladder or horizontal bracing that is uniformly spaced at intervals no greater than 18 inches, and the leads shall be equipped with adequate anchorages for use with a personal fall protection system. The operator of the equipment will apply all brakes and necessary safety switches to prevent uncontrolled motion of the equipment before an employee may access the leads. **1600(f)**
- F. Fall protection must be provided when workers are exposed to unguarded platforms or walkways exceeding 7 1/2 ft. in height. **1670(a)**
- G. Walkways that are at least 20 inches wide must be provided for access to all work areas. **1600(h)**
- H. Employees shall not ride the hammer, crane load block, or overhaul ball. Sheet piling shall be firmly stabilized before workers are permitted to work on them. **1600(g)**
- I. Where a drop hammer is used for driving piling, other than sheet piling, a driving head or bonnet shall be provided to bell the head of the pile and hold it true in the leads. **1600(h)(3)**  
The pile hammer, clamp, power unit, and supply hoses shall be inspected in accordance with their manufacturer's recommendations. **1600(i)**
- J. Adequate and accessible flotation gear (e.g., ring buoys, a lifesaving boat) must be provided to protect workers who are exposed to a drowning hazard. **1600(j), (k)**
- K. The engine or winch operator shall receive signals only from a designated signaler. **1600(l)**  
*Exception: When an employee is aloft in the leads, the hammer shall not be moved except on the signal of the employee aloft.*
- L. A hammer stop block is required. **1600(o)**
- M. Two steam (or compressed air) shutoff valves are required; one must be a quick-acting valve within reach of the hammer operator. **1600(c)(2)**
- N. Rigs must be stabilized with guys or outriggers when needed. Hammers shall be lowered to the bottom of the leads while the pile driver is being moved (traveling). **1600(p)**
- O. Piles shall be unloaded and stored in a controlled manner. **1601**
- P. The rated capacity of the hammer's suspension shall not

be exceeded. The manufacturer's recommendations for extracting piling shall be observed at all times. **1600.1**

- Q. Barges or floats used in pile driving shall meet the requirements of **Article 13**.

## Pressurized Worksites

Pressurized worksites (also known as compressed-air worksites) are sites where employees perform duties in a pressurized environment, such as a caisson. Employees working on pressurized worksites may be exposed to some specific health and safety hazards due to compression and decompression.

These hazards are similar to hazards found in diving operations, pressurized tunneling operations, and confined spaces.

Employees may develop decompression sickness (bends) from exposure to decompression. The symptoms of decompression sickness include headache, unusual tiredness, rash, pain in one or more joints, tingling in the arms or legs, muscular weakness or paralysis, breathing difficulties, shock, unconsciousness, or death.

Also, in a pressurized work environment, structural failures or blowouts may occur. This may lead to the work area becoming inundated with mud and water, causing drowning and asphyxia.

- A. Cal/OSHA must receive written notification at least seven days before the work is started. **6075**
- B. Regulatory requirements for pressurized (hyperbaric) work environments include:
  1. Following the guidelines for proper compression of employees as per **6080(a)**.
  2. Not subjecting employees to pressure exceeding 50 pounds per square inch. **6080(b)**
  3. Not allowing employees working in compressed air to pass from the working chamber to atmospheric pressure until after decompression, in accordance with **6085, 6090**.

*Exception: The requirements above do not apply in an emergency. **6080***

  4. Controlling decompression of employees as discussed in **6085**.
  5. Decompression of employees in accordance with the specified decompression tables of the U.S. Navy Diving

Manual, Volume 2, Chapter 9, 2008. **6085**

*Exception: Requirements #4 and #5 do not apply in an emergency provided that employees are decompressed in accordance with decompression tables and procedures recommended by the supervising physician.*

6. Temperature, illumination, sanitation, and ventilation as per **6100**. Ventilation in the locks and chambers, with the exception of the medical chamber, shall be such that the air quality meets the requirement of section **5144(i)**. Ventilating air shall be not less than 30 cubic ft. per minute per person. **6100**
  7. Providing forced ventilation during decompression to ensure a source of fresh air. **6100(f)**
  8. Taking one or both of the following steps when an oxygen breathing gas system is used during decompression, to ensure that the concentration of oxygen inside the chamber or lock does not exceed 25 percent (25%) by volume: **6100(i)**
    - a. The oxygen breathing gas system shall capture the oxygen that is not consumed by the user and directly exhaust it to a well-ventilated area outside of the lock or chamber.
    - b. An oxygen meter shall be used to continuously monitor the oxygen concentration inside the chamber or lock.
  9. Retaining a supervising physician who shall be available at all times while pressurized work is in progress in order to provide medical supervision of employees employed in compressed air work. **6120**
  10. Following fire prevention and oxygen safety requirements as specified in **6115**.
- C. Employees who are exposed to or control the exposure of others to hyperbaric conditions shall be trained in hyperbaric related physics and physiology, recognition of pressure related injuries, and how to avoid discomfort during compression. **6075**

## Qualified Person

A qualified person is a person designated by the employer, and who by reason of training, experience, or instruction has demonstrated the ability to perform safely all assigned duties;

and, when required, is properly licensed in accordance with federal, state, or local laws and regulations. **1504** The CSOs refer to a Qualified Person in several of the regulations.

## Ramps and Runways

Regulations concerning ramps and runways are as follows:

### A. General requirements

1. Ramps must be properly designed to provide a safe means of access for foot or vehicle traffic. **1623, 1624, 1625**
2. Open sides of ramps that are 7 1/2 ft. or more above ground must have standard guardrails. **1621(a)**

### B. Foot ramps

1. Foot ramps must be at least 20 inches wide and must be secured and supported to avoid deflection or springing action. **1624(a)**
2. If the ramp slope exceeds 2 ft. of rise for every 10 ft. of run, cleats must be 8 inches or more in length and must be placed not more than 16 inches apart. **1624**

### C. Wheelbarrow ramps and runways

1. Wheelbarrow ramps and runways must be firmly secured against displacement. **1624(c)**
2. Ramps more than 3 ft. high must be 30 inches wide, and planks must be firmly cleated together. **1623**
3. Falsework design loads must be increased by 10 psf for worker-propelled carts. **1717(a)**

## Roofing Operations

Working conditions at roofing projects are often difficult and continuously expose workers to serious hazards. In California, one of the most common causes of work-related deaths is falls from roofs. Injuries common to the roofing industry include (1) broken bones because of falls; (2) back injuries because of awkward postures and heavy lifting; and (3) burns from contact with hot roofing asphalt and associated equipment.

Roofing operations are classified as either single-unit or multi-unit. Examples of single-unit (monolithic) roofing are built-up

roofing, flat-seam metal roofing, and vinyl roofing. Examples of multi-unit roofing are asphalt shingles, cement, clay and slate tile, standing seam metal panels, shingle metal roofing, and wood shingles.

Employees shall be protected from falls from roofs. The following regulations aim to minimize or eliminate the hazards associated with the roofing industry:

A. Specific fall protection methods are used for: **1730**

- Different roof heights and slope conditions
- Different types of roofing operations including custom-built homes
- Re-roofing operations
- Roofing replacements or additions on existing residential dwelling units
- Roofing operations (including new production-type residential construction) with slopes less than 3:12

1. For single-unit roofs with slopes of 0:12 through 4:12 and more than 20 ft. in height. **1730(b)**
  - a. Warning lines and headers **1730(b)**
  - b. Personal fall protection systems as per **1724(f)**
  - c. Catch platforms with guardrails **1724(c)**
  - d. Scaffold platforms **1724(d)**
  - e. Eave barriers **1724(e)**
  - f. Parapets that are 24 inches or higher **1730(b)**
  - g. Standard railings and toeboards. **Article 16**

**Exceptions: 1730(b)**

» *Whenever any equipment is pulled by an operator who walks backwards, one or a combination of the above methods shall be applied regardless of height.*

» *At those job sites where any equipment is pulled by an operator who walks backwards or an operator rides motorized equipment, the parapet must be 36 inches or more in height at those roof edges which are perpendicular (or nearly so) to the direction in which the equipment is moving.*

2. For single-unit roofs with slopes exceeding 4:12 and more than 20 ft. in height: **1730(c)**

- a. Parapets that are 24 inches or higher **1730(c)**
- b. Personal fall protection systems as per **1724(f)**
- c. Catch platforms **1724(c)**
- d. Scaffold platforms **1724(d)**
- e. Eave barriers **1724(e)**
- f. Standard railings and toeboards. **Article 16**

**Exception:**

*Provisions in 1730(c) do not apply at job sites where the motorized equipment on which the operator rides:*

» *Has been designed for use on roofs having slopes greater than 4:12 and*

» *Is used where a parapet is:*

- i. At least 36 inches high at roof edges and*
- ii. Perpendicular to the direction in which the equipment is moving*

3. For single-unit roofs with slopes exceeding 4:12, no equipment that is pulled by an operator walking backwards shall be used.
4. For multi-unit roofs with slopes 0:12 through 5:12 and more than 20 ft. in height, employees shall be protected from falls by the use of one of the following: **1730(c)**
  - a. A roof jack system as provided in section **1724(a)**
  - b. A minimum of 24-inch-high parapet
  - c. Other methods affording equivalent protection
5. For multi-unit roofs with slopes exceeding 5:12 and more than 20 ft. in height, employees shall be protected from falls by the use of one or a combination of the following: **1730(f)**
  - a. Parapets that are at least 24 inches high
  - b. Personal fall protection systems as per **1724(f)**
  - c. Catch platforms **1724(c)**
  - d. Scaffold platforms **1724(d)**
  - e. Eave barriers **1724(e)**
  - f. Roof jack systems (safety lines are required when using roof jack systems on roofs steeper than 7:12) **1724(a)**

- B. New production-type residential construction with roof slopes of 3:12 or greater have specific fall protection requirements. **1731**
1. For New Production-Type Residential Construction with slopes 3:12 through 7:12 and the eave height exceeds 15 ft. above the grade or level below, employees shall be protected from falling when on a roof surface by use of one or any combination of the following methods:
    - a. Personal Fall Protection **1670**
    - b. Catch Platforms **1724(c)**
    - c. Scaffold Platforms **1724(d)**
    - d. Eave Barriers **1724(e)**
    - e. Standard Railings and Toeboards. **Article 16**
    - f. Roof Jack Systems **1724(a)**
  2. For New Production-Type Residential Construction with slopes greater than 7:12 regardless of height, employees shall be protected from falling by methods prescribed in the above subsections a, b, c, and e. **1731(c)**
- C. Roofing operations require documented employee training. For New Production-Type Residential Construction, training shall include the following in addition to those required by **1509** and **3203**:
1. Work on or near gable ends
  2. Slipping hazards
  3. Roof holes and openings
  4. Skylights
  5. Work on ladders and scaffolds
  6. Access to the roof
  7. Placement and location of materials on the roof
  8. Impalement hazards
  9. Care and use of fall protection systems
- D. Hot operations are subject to the following regulations:
1. Workers must not carry buckets containing hot material up ladders. **1725(a)**
  2. An attendant must be stationed within 100 ft. of any kettle not equipped with a thermostat. **1725(d)**
3. Liquefied petroleum gas cylinders must not be located where the burner will increase the temperature of the cylinder. **1725(g)**
  4. A Class BC fire extinguisher shall be kept near each kettle in use, as shown below:
    - a. For a kettle with a capacity of less than 150 gal. = 8:BC
    - b. For a kettle with a capacity of 150 gal. to 350 gal. = 16:BC
    - c. For a kettle with a capacity of more than 350 gal. = 20:BC **1726(d)**
  5. The fuel tanks of compressed-air-fueled kettles must be equipped with a relief valve set for a pressure not to exceed 60 psi. **1726(c)**
  6. Coal tar pitch operations are subject to the following requirements:
    - a. Workers must use skin protection. **1728(a)**
    - b. Washing or cleansing facilities must be available. **1728(c)**
    - c. Workers must use respirators and eye protection in confined spaces that are not adequately ventilated. **1728(b), 5158**
  7. Hot pitch and asphalt buckets have the following maximum capacities:
    - a. Carry buckets = 6 gal.
    - b. Mop buckets = 9 <sup>1</sup>/<sub>2</sub> gal. **1729(a) (2), (4)**
- E. Personal fall protection for roofing operations is regulated as follows: **1724(f)**
1. Personal fall arrest systems, personal fall restraint systems, and positioning devices must be installed and used in accordance with **Article 24** in the GISO. **1724(f)**
  2. Safety lines must be securely attached to substantial anchorages on the roof. **1724(f)**
  3. Roof openings must be railed or covered. Temporary railing and toeboards shall meet the requirements of sections **1620** and **1621**. The railing shall be provided on all exposed sides, except at entrances to stairways. **1632(b)(2)**
  4. The cover must be securely fastened and able to

withstand 2 times the expected load or a minimum of 400 lbs. Covers must bear a sign stating **OPENING—DO NOT REMOVE. 1632(b)(3)**

5. An employee approaching within 6 ft. of any finished skylight or skylight opening must be protected from falling through the skylight or opening as specified in **3212(e)**.

## Scaffolds

Work activities associated with scaffolds are subject to many hazards; however, falls are by far the number-one cause of injury or death among construction workers. The following requirements regulate the design, erection, use, and dismantling of scaffolds:

### A. General requirements

1. Scaffolds must be provided for work that cannot be done safely by employees standing on ladders or on solid construction that is at least 20 inches wide.

*Exception: A 12-inch-wide plank on members that are on 24-inch (or closer) centers is permitted. 1637(a)*

2. The design and construction of scaffolds must conform to applicable standards and requirements **1637**, ANSI A10.8-1988, ANSI/ASSE A10.8-2001. Standards are based on stress grade lumber. Metal or aluminum may be substituted if the structural integrity of the scaffold is maintained. **1637(b)**
3. Manufactured scaffolds shall be used in accordance with the manufacturer's recommendations. **1637(b)(4)**

*Exception: Where specific requirements that address riding on a rolling scaffold in section 1646(i) and (j) may conflict with the manufacturer's recommendations, the provisions in section 1646(i) and (j) take precedence.*

4. Each scaffold must be designed to support its own weight and 4 times the maximum load. Maximum working loads are as follows:**1637(b)**
  - a. Light-duty scaffolds: 25 psf of work platform.
  - b. Medium-duty scaffolds: 50 psf of work platform.
  - c. Heavy-duty scaffolds: 75 psf of work platform.
  - d. Special-duty scaffolds: exceeding 75 psf as determined by a qualified person or a California registered Civil

Engineer with scaffold design experience.

- e. Engineered scaffolds: as determined by a California registered Civil Engineer with scaffold design experience.
5. The erecting and dismantling of scaffolds are regulated as follows:
    - a. Scaffold erection and dismantlement must be supervised by a qualified person. **1637(k)(1)**
    - b. Scaffolds must be erected and dismantled according to design standards, engineered specifications, or manufacturer's instructions. **3328**, and **1637(k)**
    - c. A DOSH permit is required for erecting and dismantling scaffolds that exceed 3 stories or 36 ft. in height. **341(d)(5)(B)**
  6. Scaffold access: Ladders, horizontal members, and stairways must provide safe and unobstructed access to all platforms. The equipment must be located so that its use will not disturb the stability of the scaffold: **1637(n)**
    - a. Ladders may be used, as follows:
      - (1) Portable ladders shall comply with T8 CCR **3276.1675(b)**
      - (2) Fixed ladders shall comply with T8 CCR **3277.1675(c)**
      - (3) Ladders must be securely attached to scaffolds. **1637(n)**
      - (4) Ladders must extend 3 ft. above the platform, or handholds must be provided. **3276(e)(11)**
    - b. Manufactured hook-on and attachable ladders shall be securely attached to the scaffold and: **1637(n)**
      - (1) Shall be specifically designed for the type of scaffold used;
      - (2) Shall have a minimum rung length of 11 1/2 in. (29 cm);
      - (3) Shall have uniformly spaced rungs with a maximum spacing between rungs of 16 3/4 in;
      - (4) Shall be positioned so that their bottom rung is not more than 24 inches (61 cm) above the scaffold supporting level; and

- (5) When hook-on and attachable ladders are used on a supported scaffold more than 35 feet (10.7 m) high, they shall have rest platforms at 35-foot maximum vertical intervals.
- c. Horizontal members built into the end frame of a scaffold may be used to access platforms if: **1637(n)**
  - (1) The horizontal members are parallel and level.
  - (2) The horizontal members make a continuous ladder, bottom to top, with the ladder sides of the frames in a vertical line.
  - (3) The horizontal members provide sufficient clearance for a good handhold and foot space. **1637(n)**, **1644(a)**
- d. Stairways must conform to the following: **1637(n)(2)**
  - (1) Permanent stairways for scaffolds must comply with GISO requirements (i.e., **3214**, and **3622**).
  - (2) Prefabricated scaffold steps or stairs must comply with:
    - ANSI 10.8-1988 or ANSI/ASSE 10.8-2001 if manufactured on or before May 28, 2005
    - ANSI/ASSE 10.8-2001 if manufactured after May 28, 2005
- 7. Scaffolds must be secured as follows:
  - a. Scaffolds must be tied off with a double-looped No. 12 iron wire or a single-looped No. 10 iron wire or the equivalent. A compression member should prevent scaffold movement toward the structure. **1640**, **1641**, and **1644**
  - b. Light duty wooden pole scaffolds must be tied off every 20 ft. horizontally and vertically. **1640(b)**
  - c. Heavy-trade wooden pole scaffolds must be tied off every 15 ft. horizontally and vertically. **1641(f)**
  - d. Metal scaffolds must be tied off as specified in **1644(a)(5)**.
- 8. Scaffold platforms must conform to the following:
  - a. Platforms must be capable of supporting the intended load. **1644(a)(1)**, and **1637(m)**
  - b. Platforms must be planked solid (without gaps) and

cover the entire space between scaffold uprights. **1640(b)**, **1641(g)**, **1644(a)**, and **1646(e)**

*Exception: In solid planking the following gaps are permissible:*

- (1) The opening under the back railing
  - Wood scaffolds: 8-inch (max) horizontal. **1640(b)(5)**
  - Metal scaffolds: 10-inch (max) horizontal. **1644(a)(7)**
- (2) Space between the building (structure) and the platform
  - Wood scaffolds: 14-inch (max). **1640(b)(5)**
  - Metal scaffolds: 16-inch (max). **1644(a)(7)**
  - Bricklayers' scaffolds: 7-inch (max) to finished face of building. **1641(g)(2)**
- c. Platform minimum widths are as follows:
  - (1) Light duty: 20-inch **1640(b)(5)**
  - (2) Heavy trades: 4 ft. **1641(c)**
- d. Platform slope must not exceed 2 ft. vertically to 10 ft. horizontally. **1637(o)**
- e. Overhead protection is required when people are working overhead. **1637(q)**
- f. Slippery platform conditions are prohibited. **1637(p)**
- g. All scaffold platforms shall meet the planking requirements of section 1637. **3622(f)(5)**
- 9. Planking must conform as follows:
  - a. All solid sawn planking, unless specified in other orders, must be made of scaffold grade (structural plank 2200 psi) lumber (see **1504**) with a nominal dimension of at least 2" x 10". **1637(f)(1)**

Prior to being placed into service, all solid sawn wood scaffold planks shall be certified by, or bear the grade stamp of, a grading agency approved by the American Lumber Standards Committee. **1637(f)(5)**
  - b. All Douglas Fir and Southern Pine planking sized 2 x 10 inch (nominal) or 2 x 9 inch (rough) shall not exceed a maximum span as follows: **1637(f)(2)**



- (1) Light trades @ 25 psf = 10 ft.
  - (2) Medium trades @ 50 psf = 8 ft.
  - (3) Heavy trades @ 75 psf = 7 ft.
- c. The maximum permissible spans allowed for other wood species of scaffold planking shall not exceed 10 ft. and shall be determined by a licensed professional engineer. **1637(f)(3)**
- (1) All manufactured scaffold planking, including engineered wood products, laminated veneer lumber, metal, composite, and plastic planks shall be capable of supporting, without failure, its own weight and 4 times the maximum intended working load.
  - (2) Prior to being placed in service, all laminated veneer lumber scaffold planks manufactured after December 2, 2010, shall be labeled with the seal of an independent, nationally recognized, inspection agency approved by the International Accreditation Services (IAS) certifying compliance with ASTM D 5456-09a and ANSI/ASSE A10.8-2001, section 5.2.10.
  - (3) Planks with spans in excess of 10 ft. shall be labeled to indicate the maximum intended working load.
  - (4) Planks shall be used in accordance with the manufacturer's specifications.
- d. All scaffold planks shall be visually inspected for defects before use each day. **1637(f)(6)**
- e. Defective or damaged scaffold planks shall not be used and shall be removed from service. **1637(f)(7)**
- f. Planking shall overhang the ledger or support as follows:
- (1) A minimum of 6 inches **1640(b)**, **1645(b)**
  - (2) A maximum of 18 inches **1637(g)**, **1645(b)**
- g. A single plank (up to 4 ft. high) is only permitted on light-trade wooden pole and horse scaffolds. **1640(b)(5)(A)**, **1647(e)(2)**
- h. All platform planks shall not deflect more than  $\frac{1}{60}$  of the span when loaded to the manufacturer's recommended maximum load. **1637(w)**
10. Guardrails must be installed on open sides and ends of platforms that are 7  $\frac{1}{2}$  ft. or higher. **1621(a)**  
*Exception: **1644(a)(6)(A)**, **(B)***
- X braces that substitute for a mid-rail must intersect 20 inches to 30 inches above the platform.
  - X-braces that substitute for a top rail must intersect 42 inches to 48 inches above the platform, and a mid-rail must be placed at 19 inches to 25 inches above the platform.
11. Toeboards are required on all railed sides of work surfaces where employees work or pass below. **1621(b)**
12. Height limits for scaffolding are as follows:
- a. Wood (frame/post) = 60 ft. **1643**
  - b. Tube and coupler = 125 ft. **1644(b)(4)**
  - c. Tubular (welded) = 125 ft. **1644(c)(7)**  
*Exception: The above limits do not apply when the scaffolding is designed by a civil engineer registered in California.*
  - d. Horse (single) = 10 ft. **1647(b)(2)**
  - e. Horse (tiered) = 10 ft. **1647(b)(2)**
13. Prohibited scaffolds and supports: **1637(j)**
- a. Shore scaffolds
  - b. Jack scaffolds (with brackets attached to single studs)
  - c. Lean-to scaffolds
  - d. Stilts
  - e. Nailed brackets
  - f. Brick or blocks
  - g. Loose tile
  - h. Unstable objects
14. Maximum scaffold working load must be posted or provided to and available from the job site supervisor. **1637(b)(6)**
15. Prohibited work practices:
- a. Work on or from scaffolds during storms or high winds unless: **1637(u)**

- (1) A qualified person has determined that it is safe and
- (2) Employees are protected by a personal fall arrest system or wind screens.

*Note: Wind screens shall not be used unless the scaffold is secured against the anticipated wind forces. 1637(u)*

- b. Wood platforms shall not be painted with opaque finishes but can be coated with certain clear finishes. **1637(v)**

## B. Scaffold-specific requirements

After reviewing the general requirements for scaffolds, refer to the regulations listed below (and any other applicable SOs) for the specific type(s) of scaffold in use to determine whether these requirements replace or augment the general requirements.

The requirements listed below are unique to each specific type of scaffold listed:

### 1. Tubular welded scaffold systems **1644**

These scaffold systems are commercially fabricated and must meet the following requirements:

- a. Frames must nest with coupling or stacking pins to provide proper vertical alignment. **1644(c)(5)**
- b. Frame panels must be vertically pinned if uplift may occur. **1644(c)(6)**

### 2. Tower and rolling scaffolds **1646**

The specifications for tower and rolling scaffolds are as follows:

- a. The “height-to-base” must not exceed 3:1 unless the scaffold is secured. **1646(a)**
- b. A screw jack must extend  $\frac{1}{3}$  of its length into the leg tube and the exposed thread must not exceed 12 inches. **1646(b)(2)**
- c. Two wheels or casters must swivel; all four must lock. **1646(c)**
- d. A fully planked platform is required. **1646(e)**
- e. All frame and center joints shall be locked together by lock pins, bolts, or equivalent fastenings. **1646(d)**

- f. The scaffold must have horizontal diagonal bracing (see Illustration 9). **1646(b)**
- g. Railings are required if the platform is 7  $\frac{1}{2}$  ft. or more above grade. **1646(b)**
- h. Ladders or other unstable objects shall not be placed on top of rolling scaffolds to gain greater height. **1646(f)**
- i. When scaffolds are built on motor trucks or vehicles, they must be rigidly attached to the truck or vehicle. **1646(g)**
- j. Trucks or vehicles that have scaffolds attached to them shall have a device in use whenever employees are on the scaffold that prevents swaying or listing of the platforms. **1646(h)**
- k. Employees may ride on a rolling scaffold moved by others below if the following conditions exist: **1646(i)**
  - (1) The floor or surface is within 3 degrees of level, and free from pits, holes, or obstructions.
  - (2) The minimum dimension of the scaffold base, when ready for rolling, is at least  $\frac{1}{2}$  of the height. Outriggers, if used, shall be installed on both sides of staging.
  - (3) The wheels are equipped with rubber or similar resilient tires. For towers 50 ft. or over, metal wheels may be used.
  - (4) The manual force used to move the scaffold shall be applied as close to the base as practicable, but not more than 5 ft. (1.5 meters) above the supporting surface of the scaffold.
  - (5) Before a scaffold is moved, each employee on the scaffold shall be made aware of the move.
  - (6) No employee shall be on any part of the scaffold that extends outward beyond the wheels, casters, or other supports.
- l. Employees may ride and move on a Self-Propelled rolling scaffold while on the platform without assistance from others below, provided the following conditions are met: **1646(j)**
  - (1) All of the provisions in **1646(i)** shall be met, except that the scaffold need not be moved by others below.

- (2) The scaffold platform shall not be more than 4 ft. above the floor level.
- (3) The working platform shall be no less than 20 inches in width with a maximum 1-inch space between platform planks.
- (4) Wheels or casters of rolling scaffolds shall be provided with an effective locking device that is used in accordance with **1646(c)**; or rolling scaffolds shall be provided with an effective device that is used to prevent movement of the scaffold when workers are climbing or working on the scaffold.
- (5) The use of power systems such as motor vehicles, add-on motors, or battery-powered equipment to propel a rolling scaffold is prohibited.

m. Employees who ride on rolling scaffolds and employees who assist in moving employees riding on a rolling scaffold shall be trained on the hazards associated with riding on a rolling scaffold as per **1646** and **1509**.

**Illustration 9 | Tower and Rolling Scaffold**

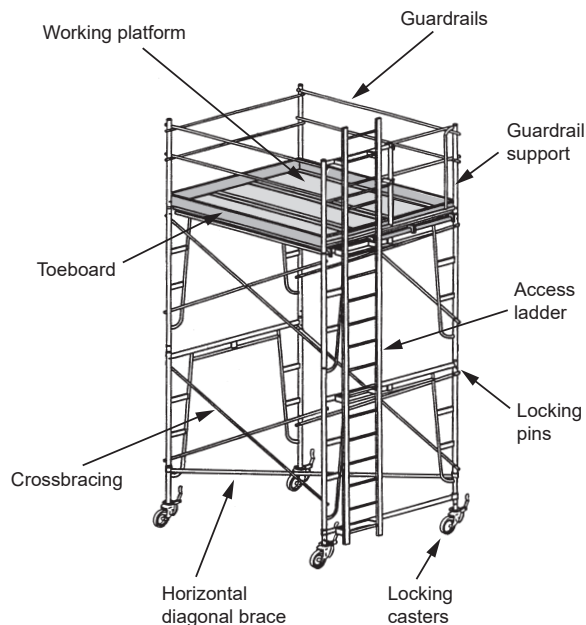

### 3. Suspended Scaffolds **1658**

- a. General requirements for suspended scaffolds (swing staging). **1658**

Most suspended scaffolding has a two-point suspension supported by hangers or stirrups. The following applies:

- (1) Each wire is suspended from a separate outrigger beam or thrustout. **1658(k)**
- (2) Multi-stage units or units with overhead protection must be equipped with additional suspension lines to support the scaffolding in case the primary suspension system fails. **1658(u)**
- (3) The scaffold must be inspected daily by a qualified person and tested frequently. **1658(g)**

- (4) When a suspended scaffold is left unattended in an elevated position, it shall be securely lashed to the building and be cleared of all tools, buckets, or other moveable materials. **1658(p)**
  - (5) All hoisting mechanisms and metal platforms must meet nationally recognized standards. **1658(a)**
  - (6) Outrigger beams must be secured in a saddle and anchored at one end to a solid structure. The inboard end must be tied back. **1658(j)**
  - (7) The beam must be capable of supporting four times the intended load. **1658(j)(1)**
  - (8) Use of a ladder as a platform is prohibited even if a horizontal work surface is added over the rungs. **1658(d)**
  - (9) The load limit is one person per suspension rope. **1660(a)**
  - (10) An insulated wire suspension rope is required when workers are welding, burning, sandblasting, or using any chemical substance that may damage the rope. **1658(f)**
  - (11) A separate safety harness and lifeline are required for each worker. **1658(i)**, **1660(g)**
  - (12) Platform dimensions must be as follows:
    - Width = 14 in. to 36 in. **1660(d)**;  
= 24 in. to 36 in. if the platform is used by cement masons. **1661(b)**
    - Span = 10 ft. (2" x 10" planks). **1660(e)**;  
= 12 ft. (2" x 12" planks). **1660(e)**
    - Bolster (ledger) = 2" x 4" cross section. **1660(c)**
- b. Specific requirements for suspended scaffolds:
- (1) Powered suspended scaffolds **1667**  
The general rules for swing scaffolds apply except as listed below:
    - The minimum platform width must be 20 inches **1667(d)**
    - Railings are required on open sides and ends, and on all sides if the scaffold is suspended by one rope. **1667(a)**
  - (2) Interior hung suspended scaffolds **1665**  
These scaffolds are of a wood or steel-tube-and-coupler type, and they are suspended from a ceiling or roof structure. The general and suspended scaffold rules apply.  
*Exception:*
    - *Suspension ropes must be wrapped twice around supporting members and ledgers. **1665(b)***
    - *Ends of wire rope must be secured with at least three clips.*
  - (3) Float suspended scaffolds. **1663**  
These scaffolds are intended for such work as welding, riveting, and bolting. **1663(a)**
    - Platform size: 3 ft. x 6 ft. x <sup>3</sup>/<sub>4</sub>-inch plywood. **1663(a)(1)**
    - Rope: 1-inch diameter manila (min.). **1663(a)(4)**
    - Load limit: Three people **1663(a)**
    - Personal fall protection and a separate lifeline: Required for each person. **1663(a)(5)**
  - (4) Boatswain's chair. **1662**  
The use of a boatswain's chair requires training or experience. **1662(a)**
    - Platform size: 10 in. x 24 in. x 2 in. **1662(i)**
    - Rope: <sup>5</sup>/<sub>8</sub>-inch diameter manila (min.) and <sup>3</sup>/<sub>8</sub>-inch diameter protected wire for welding. **1662(j)**, **(k)**
    - Personal fall protection and a separate lifeline: Required **1662(c)**
    - Area below: Barricaded. **1662(b)**
  - (5) Needle-beam scaffolds. **1664**
    - The load limit is 425 lbs. for a ladder-type platform. **1667(b)**
    - Controls must be of the dead-man type.
    - Load release units for fast descent are prohibited. **1667(f)(1)**

The specifications for needle-beam scaffolds are as follows:

- Beam size: 4 in. x 6 in. x 10 ft. **1664(a)(1)**
- Rope: 1 1/4-inch diameter manila. **1664(a)(4)**
- Personal fall protection: Required in accordance with **Article 24** in the CSOs. **1664(a)(12)**

*Note: See the hitches for holding needle beams in Illustration 10.*

(6) Outrigger scaffolds. **1645**

Outrigger scaffolds are regulated as follows:

- Brackets or beams must be anchored or braced against turning, twisting, or tipping. **1645(a)(1)**
- Platform: at least two 2-inch x 10-inch planks. **1645(a)(2), 1645(b)(5)**
- Beam size: 3 inches x 12 inches (min.). **1645(a)(2)**
- Beam length: Outboard of fulcrum must not exceed 6 ft; inboard must be 1 1/2 times the outboard section. **1645(a)(1)**

*Note: For multi-level structures, the units must be designed by a California registered Civil Engineer. **1645(a)(3)***

### Illustration 10 | Hitches for Holding Needle Beams



Square knot

Bowline

Rolling or taut-line hitch

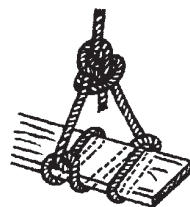

Scaffold hitch

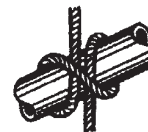

Clove hitch



Round turn and two half-hitches



Eye splice



Running bowline



Round turn and two half-hitches

(7) Bracket scaffolds (light trades). **1645**

Brackets must be bolted through walls, welded to tanks, properly secured to metal studs, or hooked over a supporting member. **1645(d)**

- Platform: 20 inches x 10 ft. (min.)
- Load limit: Carpenter's type = two workers and 75 lbs. of equipment. **1645(e)(4)**

(8) Horse scaffolds. **1647**

The specifications for horse scaffolds are as follows:

- Platform width:
  - i. Light trades = 20 inches (min.); 10 inches if the platform is less than 4 ft. high.
  - ii. Heavy trades = 4 ft. (min.). **1647(e)(2)**
- iii. Width of base legs =  $\frac{1}{2}$  x height (min.). **1647(a)(3)**
- Height:
  - i. Collapsible horse = 6 ft. (max.). **1647(d)(2)**
  - ii. Single horse = 10 ft. (max.). **1647(e)(1)**
  - iii. Two tiers (max.) = 10 ft. (max.). **1647(e)(1)**

(9) Ladder jack scaffolds. **1648**

The specifications for ladder jack scaffold platforms are as follows:

- Span = 16 ft. (max.) **1648(b)**
- Height = 16 ft. (max.) **1648(a)**
- Width = 14 in. (min.) **1648(b)**
- Load = two workers (max.) **1648(a)**

*Notes:*

» *Ladders must be Type I, IA, or IAA duty rated ladders in accordance with 3276(c). Job-built ladders shall not be used for this purpose.* **1648(d)**

» *A safety line is required for each worker.* **1648(c)**

(10) Window jack scaffolds. **1654**

The specifications for window jack scaffolds are as follows:

- Only one window per scaffold is permitted. **1654(d)**
- The load limit is one person per scaffold. **1654(d)**
- Fall protection or railings are required. **1654(c)**

## Silica Dust

Construction work that involves exposure to crystalline silica-containing materials can cause lung diseases. These silica-containing materials include (but are not limited to):

- Sand
- Rock
- Ceramic and terracotta tiles
- Concrete and concrete block
- Manufactured stone
- Roof tiles
- Bricks and blocks
- Grouts and mortar
- Some joint compounds
- Abrasive materials

Exposure to crystalline silica can cause a variety of lung diseases, including silicosis, lung cancer, COPD (chronic obstructive pulmonary disease), decreased lung function, increased likelihood of getting tuberculosis, and immune system and kidney effects. Although most cases of silicosis develop after years of exposure, instances of extremely high exposure have resulted in illness and even death in a matter of weeks.

The 8-hour permissible exposure limit (PEL) for airborne crystalline silica is established at 0.05 mg/m<sup>3</sup> with an Action Level of 0.025 mg/m<sup>3</sup> (see Table **AC-1** of **5155** and **section 1532.3**).

Hazardous work activities include abrasive blasting with sand and loading, dumping, chipping, hammering, cutting, and drilling of rock, sand, or concrete. Generally, during work on materials, such as rock or concrete that contain a significant amount of silica, continuous exposure to a visible cloud of dust will probably result in levels of exposure that exceed the PELs. However, in some cases the PELs can be exceeded even when there is no visible cloud of dust.

For additional information on the hazards and control of silica exposures see the:

*Hazards of Silica in Construction eTool* ([www.dir.ca.gov/dosh/etools/08-019/index.htm](http://www.dir.ca.gov/dosh/etools/08-019/index.htm))

Respirable Crystalline Silica Standards Update and FAQ ([www.dir.ca.gov/dosh/respiratory-silica-FAQ.html](http://www.dir.ca.gov/dosh/respiratory-silica-FAQ.html)).

Before beginning work that could expose employees to crystalline silica, employers must comply with the following requirements:

- A. Know and understand T8 CCR sections **1532.3** and **1530.1**. Section **1530.1** contains certain requirements not found in **1532.3**, such as:
  - 1. Procedures to ensure that dust reduction systems maintain their effectiveness.
  - 2. Additional training topics for employees and supervisors.
- B. Methods of exposure control or compliance. **1532.3(c)** or **(d)(3)**
- C. Exposure assessments. **1532.3(d)(2)**
- D. Respiratory protection. **1532.3(e)**
- E. Housekeeping. **1532.3(f)**
- F. Restricted areas. **1532.3(g)(1)(D)**
- G. Written exposure control plan. **1532.3(g)**
- H. Medical surveillance. **1532.3(h)**
- I. Communication of respirable crystalline silica hazards to employees. **1532.3(i)**
- J. Recordkeeping. **1532.3(j)**

## Stairways

Stairways are an acceptable method for gaining access to floors and working levels of buildings and scaffolds.

In addition to the stairways required, buildings 60 ft. or more in height or 48 ft. below ground level require an elevator. **1630(a)**

Stairways must be installed as follows:

- A. In buildings of up to three stories or 36 ft. in height, at least one stairway is required. **1629(a)(4)**
- B. In buildings of more than three stories or 36 ft. in height, two or more stairways are required. **1629(a)(4)**
- C. A stairway to a second or higher floor must be installed before studs are raised to support the next higher floor. **1629(b)(1)(A)**
- D. In steel frame buildings, a stairway must be installed leading

up to each planked floor. **1629(b)(2)**

- E. In concrete buildings, a stairway must be installed to the floor that supports the vertical shoring system. **1629(b)(3)**
- F. Stairways shall be at least 24 inches in width and shall be equipped with stair rails, handrails, treads, and landings.
- G. All guardrails, including their connections and anchorage, shall be capable of withstanding a load as specified in **1620(c)**.
- H. Handrails must be 34 inches to 38 inches above the tread nosing. **1626(c)(6)**
- I. Wooden posts shall be not less than 2-inch by 4-inch in cross section, spaced at 8 ft. or closer intervals. Wooden top railings shall be smooth and of 2-inch by 4-inch or larger material. Double 1-inch by 4-inch members may be used as top railings when certain conditions are met. **1620(b)(2), (3)**
- J. Railings and toeboards must be installed around stairwells. **1626(a)(2)**
- K. The stairway shall have landings at each floor or level of not less than 30 inches in the direction of travel and extend at least 24 inches in width at every 12 ft. or less of vertical rise. **1626(a)(2)**
- L. Stair steps must be illuminated with at least 5 foot-candles of light and all lamps must be guarded. **1629(a)(7)**

## Temporary Agencies

- A. Host employers have the primary responsibility for maintaining safe worksites. Temporary (temp) agencies are responsible for:
  - 1. Determining the conditions at the worksite.
  - 2. Providing basic safety information to temp employees.
  - 3. Informing the temp employees how to get specific information on protection from hazards at the host site.
- B. To ensure a clear understanding of each employer's role, Cal/OSHA recommends temp agency and host employer to establish responsibilities in their contract.
- C. In general, temp agencies are responsible for ensuring that employees have received proper training. Host employer is responsible for the site-specific trainings appropriate to the employees' particular task.

D. Both the temp agencies and the host employer need to follow all relevant California labor laws and T8 CCR as they relate to the health and safety of their employees. Requirements include:

1. Have a written, effective, and fully implemented IIPP. **3203**
2. In a dual-employer worksite, where an employee has two employers at the same time, contact Cal/OSHA for regulatory requirements.
3. In a multi-employer worksite, where two or more employers have their employees working, employers need to follow requirements as per T8CCR sections **336.10** and **336.11**.

E. Injury and illness records should be kept by:

1. Where temp agency exercises day-to-day supervision, the temp agency keeps the records.
2. Where temp agency and host employer share the supervision, the two employers reach an agreement on who keeps the records.
3. Where the host employer exercises supervision, the host employer keeps the records.

*Note: Only one employer's log should contain a record of injuries and illnesses of the employees.*

F. Temp agencies need to keep in touch with their employees and monitor their safety and health at work on a regular basis.

## Toeboards

Regulations concerning toeboards include the following:

- A. Toeboards must be provided on all open sides and ends of railed scaffolds at locations where persons are required to work or to pass under the scaffold and at all interior floor, roof, and shaft openings. **1621(b)**
- B. Specifications for toeboards are as follows:
  1. A toeboard must be securely fastened at a minimum of 4 inches (nominal) in height from its top edge to the level of the floor, platform, runway, or ramp. A toeboard must have not more than a  $\frac{1}{4}$  in. clearance above the floor level. It

may be made of any substantial material, either solid or with openings not more than 1 inch in greatest dimension. **1621(b)**

2. Where material is piled to such a height that a standard toeboard does not provide protection, paneling or screening from floor to intermediate rail or top rail shall be provided. **1621(c)**

## Toilets/Washing Facilities/ Sanitation

Regulations concerning toilets, hand washing, and sanitation include the following:

- A. Toilet facilities are required at the job site. **1526(b)**
- B. A toilet is required for each 20 employees or fraction thereof of each sex; urinals may be substituted for half of the units. **1526(a)**

*Exceptions:*

*»Sites with fewer than five employees are only required to provide one single-user toilet (a toilet facility that is lockable from the inside with one toilet, or one toilet and one urinal) designated for all-gender use. 1526(a)(1)*

*»Sites may use single-user toilets designated for all-gender use as long as the total number of toilets provided meets the requirements of 1526(a), all single-user toilets are designated for all-gender use, and all multi-user separate toilet facilities are provided in equal number to each sex. 1526(a)(2)*

- C. Toilets must be kept clean and supplied with toilet paper. **1526(d)**
- D. Toilets are not required for mobile crews if transportation to nearby toilets is available. **1526(e)**
- E. One washing station must be provided for each 20 employees or fraction thereof. **1527(a)**
- F. Washing stations must be clean and have an adequate supply of soap, water, and single-use towels (or warm air blower). **1527(a)**



- G. Washing station must have a sign indicating water is for washing. **1527(a)(1)(F)**
- H. Wash stations are to be located outside and not attached to the toilet facility. **1527(a)(1)(F)**

*Exception: Where there are less than five employees and only one toilet facility is required, the wash station may be located inside the toilet facility.*

- I. If showering is required by the employer, the shower must meet specific requirements. **1527(a)(3)**
- J. An adequate supply of potable (drinkable) water must be provided at each job site. The employer shall take one or more of the following steps to ensure every employee has access to drinking water: **1524(a)**
  - 1. Provide drinking fountains.
  - 2. Supply single-service cups.
  - 3. Supply sealed one-time use water containers.
  - 4. Ensure reusable, closable containers are available for individual employee use.

*Note: Additional requirements for the provision of drinking water in outdoor places of employment are contained in **3395**.*

## Tools and Equipment

General requirements for tools and equipment include:

- Tools must be kept clean and in good repair. **1699**
  - Only trained or experienced employees may operate tools, machines, or equipment. **1510(b)**
  - Power-operated tools must be grounded or of the double-insulated type. If double-insulated types of tools are used, the equipment shall be distinctively marked. **2395.45**
  - Power-operated tools should be kept out of wet locations. **2395.45**
- A. Power-operated tools shall be grounded under the following conditions: **2395.45**
    - 1. Utilization equipment used in hazardous (classified) locations (See **Article 59**).
    - 2. Hand-held motor-operated tools, stationary and fixed

motor-operated tools, and light industrial motor-operated tools.

- 3. Motor-operated tools and utilization equipment of the following types: Drills, hedge clippers, lawn mowers, snow blowers, wet scrubbers, sanders, and saws.
- 4. Tools likely to be used in wet and conductive locations.

*Notes:*

» *The following shall not be required to be grounded:*  
**2395.45**

- i. Listed portable tools or utilization equipment likely to be used in wet and conductive locations if supplied through an isolating transformer with an ungrounded secondary of not over 50 volts.
  - ii. Listed or labeled portable tools and utilization equipment protected by an approved system of double insulation. Where such a system is employed, the equipment shall be distinctively marked.
- » *Double-insulated type power-operated tools are not required to be grounded.*
- B. Guards required by the SOs must not be removed or deactivated. **3942**
  - C. Control switches for powered hand tools are subject to the regulations noted below:
    - 1. The following tools must be equipped with a constant-contact (dead-man) on-off switch: **3557(a)**
      - a. Drills
      - b. Tappers
      - c. Fastener drivers
      - d. Grinders
      - e. Disc and belt sanders
      - f. Reciprocating saws
      - g. Circular saws
      - h. Chain saws
      - i. Concrete vibrators
      - j. Concrete breakers

- k. Concrete trowels
  - l. Powered tampers
  - m. Jackhammers
  - n. Rock drills
  - o. Tools similar to those above
2. Hoisting or lowering electric tools by their cords is prohibited. **1707(a)**
- D. Powder-actuated tools (PAT) shall be approved for their intended use as defined in **1505**, or have California approval numbers. **1684(a)(1), (2)**
1. Only trained workers holding a valid operator's card may use a PAT. **1685(a)(1)**
  2. Containers must be lockable and bear a label that says **POWDER-ACTUATED TOOL** on the outside. The storage container must be kept under lock and key. **1687(a)**
  3. The PAT must be provided with the following:
    - a. An operating and service manual
    - b. A power load and fastener chart
    - c. An inspection and service record
    - d. Repair and servicing tools. **1687(b)**
  4. Limitations on the use of PATs are as follows:
    - a. Workers must not leave the tool unattended. **1690(b)**
    - b. Workers must not use the tool:
      - (1) In an explosive environment. **1690(a)**
      - (2) On hard or brittle material. **1690(c)**
      - (3) On easily penetrated or thin materials or materials of questionable resistance unless backed. **1690(d)**
      - (4) Within a 1/2-inch of the edge of steel. **1690(e)**
      - (5) Within 3 inches of the edge of masonry. **1690(f)**
      - (6) On thin concrete. **1690(g)**
      - (7) On spalled areas. **1690(h)**
      - (8) On existing holes. **1690(i)**
  5. Requirements for operating PATs are as noted:
    - a. Eye or face protection is required for operators and assistants. **1691(b)**
    - b. Operators must inspect the tool before using it. **1691(c)**
    - c. Defective tools must not be used. **1691(d)**
    - d. Tools must not be loaded until ready for use. **1691(g)**
    - e. Tools must be unloaded if work is interrupted. **1691(h)**
    - f. Operators must never point a loaded tool or an empty tool at anyone. **1691(i)**
    - g. The tool must be held in place for 30 seconds on misfire. **1691(l)**
    - h. Different power loads must be kept in separate compartments. **1691(m)**
    - i. Warning signs that say **POWDER-ACTUATED TOOLS IN USE** must be conspicuously displayed within 50 ft. of a PAT operation. **1691(n)**
    - j. Misfires and skipped power charges must be stored and disposed of properly. **1689(c), 1691(a)**
- E. Concrete-finishing tools must be equipped with a dead-man-type control. **1698(d)**
- F. Airless spray guns must have an automatic or visible manual release safety device or a diffuser nut and tip guard. **3559.1(a)**
- G. Circular power saws are regulated as follows:
1. Portable Circular power saws:
    - a. All saws shall be equipped with guards above and below the base plate or shoe. **4307(a)**
    - b. Teeth on the upper half of the saw blade must be permanently guarded. **4307(a)**  
*Exception: The upper guard shall cover the saw to the depth of the teeth, except for the minimum arc required to permit the base to be tilted for bevel cuts.*
    - c. Teeth on the lower half of the saw blade must be guarded with a telescopic or hinged guard. The lower guard must automatically and instantly return to the covering position when the tool is withdrawn from the work. **4307(b)**  
*Exception: The lower guard shall cover the saw to the*

*depth of the teeth, except for the minimum arc required to allow proper retraction and contact with the work.*

- d. Saw guards must not be blocked open to prevent guards from functioning. **4307(c)**
2. Self-feed Circular power saws: **4301**
    - a. In addition to guards over blades as specified in **4296**, feed rolls shall be protected by a hood or guard.
    - b. The employer shall ensure that power feed devices are properly adjusted for each piece of stock in order to reduce the possibility of kickback.
    - c. Every self-feed circular rip saw shall be equipped with an anti-kickback device installed on the infeed side.

*Note: The arbor speed of circular saw blades shall not exceed speeds recommended by the manufacturer.*

- H. Miter (chop) saws are regulated as follows: **4307.1**
  1. With the carriage in the full cut position, a guard must enclose the upper half of the blade and at least 50 percent of the arbor end. **4307.1(a)**
  2. With the carriage in the full retract (raised) position, lower blade teeth must be fully guarded, and the guard must extend at least  $\frac{3}{4}$ -inch beyond the teeth. **4307.1(b)**
  3. Employers shall instruct employees to keep hands and fingers outside the area below the blade until the blade has come to a complete stop. **4307.1(c)**
- I. Stump cutters are regulated as follows: **3428**
  1. Stump cutters shall be equipped with enclosures or guards to protect employees.
  2. Each employee in the immediate area of stump grinding operations shall wear PPE as required by **Article 10** of the GISO.
- J. Radial arm (horizontal pull) saws are regulated as follows:
  1. The upper half of the saw blade and arbor ends must be completely covered. **4309(a)**
  2. The sides of the lower exposed portion of the blade shall be guarded as per **4309(a)(2)**.
  3. An anti-kickback device must be used during ripping operations. **4309(c)**
  4. Saws must return automatically to the table's back when

released. **4309(d)**

5. Saws must have a stop provided to prevent the saw blade from passing the front edge of the table. **4309(b)**
- K. Table saws are regulated as follows:
    1. A hood must cover the saw to at least the depth of the teeth. **4300(a)**
    2. The hood shall automatically adjust itself to the thickness of the material being cut at the point where the stock encounters the saw blade. The hood may be a fixed or manually adjusted hood or guard provided the space between the bottom of the guard and the material being cut does not exceed  $\frac{1}{4}$ -inch. **4300(b), (c)**
    3. Table saws must be equipped with an anti-kickback device during ripping operations. **4300(d)**
    4. Push sticks or push blocks shall be provided at the workplace in the several sizes and types suitable for the work to be done. **4300(f)**

*Note: The arbor speed of circular saw blades shall not exceed speeds recommended by the manufacturer.*

- L. Band saws are regulated as follows:
  1. All portions of the band saw blade must be guarded except between the guide rolls and the table. **4310(a)(1)**
  2. Band saw wheels must be enclosed. **4310(a)(2)**
- M. Chain saws are regulated as follows:
  1. Chain saws must be started on the ground or where it is otherwise firmly supported. **3425(a)(2)**
    - a. Chain saws must not be drop started, as defined in **3420**.
    - b. Chain saws must not be started from an elevated position unless the area below is clear of personnel.
  2. Chain saws weighing more than fifteen pounds used in trees must be supported by a separate line or tool lanyard, except when working from an aerial-lift device or during topping or removing operations where no supported limb is available. **3425(a)(3)**
  3. Chain saws must be equipped with a constant-pressure control that returns the saw to idling speed when released. **3425(a)(4)**

4. A chain saw must not be started and operated unless everyone, except the operator, is clear of the saw. **3425(a)(5)**
  5. A chain saw shall not be running when it is being carried up into a tree. **3425(a)(6)**
  6. Chain saws must have a clutch adjusted to prevent the chain drive from engaging at idling speed. **3425(a)(7)**
  7. Chain saws must be stopped when carried for a distance longer than 100 feet, or in hazardous conditions such as slippery surfaces or heavy underbrush. **3425(a)(8)**
  8. Chain brakes must be engaged or the engine stopped when the saw is carried more than 10 feet in distance. **3425(a)(8)**
  9. The chain saw must be stopped for cleaning, refueling, adjustments, and repairs except where manufacturers' instructions require otherwise. **3425(a)(9)**
  10. If operating a chain saw in a tree, use a second point of attachment such as a work-positioning lanyard or double-crotched rope, unless the employer demonstrates that this causes a greater hazard. **3425(a)(10)**
  11. Chain saws must be equipped with a quick shutoff switch readily accessible to the operator. **3425(a)(12)**
- N. Pneumatic tools are regulated as follows:
1. Safety clips are required on pneumatic tools to prevent dies from being accidentally expelled from the barrel. **3559(a)**
  2. Pneumatic nailers and staplers must have a safety device that prevents the tool from operating when the muzzle is not in contact with the work surface. **1704(b)**
- Exception: Light-Duty Nailers and Staplers*
3. Pneumatic nailers and staplers must be disconnected from the air supply at the tool when performing any maintenance or repair on the tool, or when clearing a jam. **1704(c)**
  4. The air hose of pneumatic nailers and staplers must be secured at roof level to provide ample but not excessive amounts of hose when an operator works on roofs sloped steeper than 7:12. **1704(d)**
  5. All pneumatic hoses exceeding 1/2-inch inside diameter shall have a safety device at the source of supply or branch line to reduce pressure in case of hose failure. **1704(e)**
6. Jackhammer operators must wear personal protective equipment when required (see Personal Protective Equipment section in this guide), including foot protection as per **3385**. Jackhammer operators must also use hearing protection when noise levels exceed allowable exposure levels as per **5096(a)**.
  - O. All portable pipe threading/cutting machines, portable power-driven augers (earth drills), and portable power drives shall be permanently equipped with a momentary contact device. **4086**

## Traffic Control

Regulations concerning traffic control are noted below:

- A. Worksite traffic controls and placement of warning signs must conform to the requirements of the "California Manual on Uniform Traffic Control Devices for Streets and Highways, January 13, 2012" published by the State Department of Transportation. Additional means of traffic control, such as continuous patrol, detours, barricades, or other techniques for the safety of employees may be employed. **1598(a)**
- B. Specifications for the size and design of signs, lights, and devices used for traffic control shall be as described in the "Manual," pursuant to the provisions of California Vehicle Code section 21400, which is incorporated by this reference. **1598(b)**
- C. Employees (on foot), such as grade-checkers, surveyors, and others exposed to the hazard of vehicular traffic, shall wear high-visibility safety apparel in accordance with the requirements of **1598**, **1599**, and **1590**.  
*Note: The warning garments such as vests, jackets, or shirts shall be manufactured in accordance with the requirements of the ANSI/ISEA 107-2004, High Visibility Safety Apparel and Headwear. **1598(c)***
- D. Flaggers (see Flaggers section in this guide) are required when the controls cited above are inadequate. **1599(a)**  
*Note: The use of one flagger under specified circumstances is also permitted. **1599(a)***
- E. The employer shall select the proper type (class) of high-visibility safety apparel for a given occupational activity

by consulting the Manual, apparel manufacturer, ANSI/ISEA 107-2004, Appendix B or the American Traffic Safety Services Association (ATSSA). **1599(f)**

## Training

Each year, serious and fatal injuries are caused by ineffective and inadequate training of employees. Employees who are newly hired, given new job duties, or who are using tools and equipment that they are unfamiliar with have a greater risk of being injured.

### A. Effective Training

Effective training relates directly to the work being done by employees. It instructs employees on general safe work practices and also provides specific information on the hazards they may encounter in their jobs. In general, effective training instructs employees on how to work safely and:

1. Communicates information in a language and by methods understandable to all employees (including those who do not speak English or have limited comprehension of English)
2. Helps establish a relationship with employees to improve trust and communication
3. Is participatory and involves employees by drawing on their own real life experiences
4. Allows group hazard identification and problem solving by means of demonstrations, asking questions, discussing ideas, and providing observations and stories
5. Provides opportunities to demonstrate newly learned safe work practices and the safe use of tools, equipment, and chemicals
6. Provides concrete safety and health changes in how work is set-up and performed
7. Is repeated as often as necessary
8. Encourages employees to express safety concerns and to make suggestions

For help with your workplace training, see the Effective Workplace Training eTool ([www.dir.ca.gov/dosh/etools/09-002/index.htm](http://www.dir.ca.gov/dosh/etools/09-002/index.htm)).

### B. Training Requirements

The specific Cal/OSHA training requirements that apply to each worksite depend on the work activities in which employees are involved. Cal/OSHA has a list of Safety and Health Training and Instruction Requirements organized by training topics. This list has requirements contained in the CSOs and GISOs ([www.dir.ca.gov/dosh/dosh\\_publications/TrainingReq.htm](http://www.dir.ca.gov/dosh/dosh_publications/TrainingReq.htm)).

The SOs require training employees when:

1. They are first hired. **1510(a)**, **3203(a)**
2. They will operate machinery and equipment (see the Qualified Person section in this guide).
3. They are given a new job assignment for which they have not previously received training. **3203(a)(7)(C)**
4. They are exposed to known job-site hazards, such as poisons, hazardous materials and gases, harmful plants and animals, etc. **1510(c)**
5. New substances, processes, procedures, or equipment are introduced to the workplace and represent a new hazard. **3203(a)(7)(D)**
6. The employer is made aware of a new or previously unrecognized hazard. **3203(a)(7)(E)**
7. Supervisors need to familiarize themselves with the safety and health hazards to which employees under their immediate direction and control may be exposed. **3203(a)(7)(F)**
8. Tailgate or toolbox safety meetings are held (at least every 10 working days). **1509(e)**

*Exception: For tunneling operations tailgate meetings must be held weekly. **8406(e)***

*Note: Cal/OSHA has a large number of regulations that require employee training. The list above includes only some of the Cal/OSHA regulations that require training.*

The complete set of Cal/OSHA regulations in Title 8 can be found at [www.dir.ca.gov/samples/search/query.htm](http://www.dir.ca.gov/samples/search/query.htm).

## Tunnels and Tunneling

Employees working on tunneling operations are exposed to numerous hazards, including:

1. Tunnel collapses;
2. Hazardous atmospheres; and
3. Explosive atmospheres.

Employees working on pressurized tunneling operations may also be exposed to hazardous hyperbaric conditions.

When employees work in tunnels, underground chambers of any depth, and shafts planned to exceed 20 ft. in depth, the following operations are subject to the Tunnel Safety Orders (TSOs):

- Pipe-jacking and boring
- Micro-tunneling
- Mechanized tunneling
- Drill and blast work
- Excavation
- Ground support work
- Repair and maintenance
- Tunnel renovations

Employees who are exposed to or control the exposure of others to hyperbaric conditions shall be trained in hyperbaric-related physics and physiology, recognition of pressure-related injuries, and how to avoid discomfort during compression. **6075(c)**

The Mining and Tunneling (M&T) Unit of Cal/OSHA enforces the TSOs, which include:

- A. Classifications: The M&T Unit is required to classify the gas hazards of each tunnel or shaft. These classifications are: **8422(a), (b)**
1. Nongassy;
  2. Potentially gassy;
  3. Gassy; and
  4. Extra hazardous.

*Note: The request for classification shall be sent to the nearest M&T Unit office.*

- B. Pre-job safety conference: Before underground excavation may begin, the M&T Unit must conduct an on-site, pre-job safety conference with the project owner, the general contractor, the tunnel contractor, and the tunnel contractor's employees. The goal of the conference is to ensure that all

of the employees are aware of the conditions under which the tunnel will be driven and that all of the safety issues are discussed and problems resolved. **8408**

- C. Certified persons: Cal/OSHA requires the persons performing the duties of gas tester or safety representative to be certified by passing a written and an oral examination administered by the M&T Unit. **8406(f), (h)**

1. A certified gas tester is required for the following operations:
    - a. After blasting operations
    - b. Projects during which diesel equipment is used underground
    - c. Hazardous underground gas conditions. **8406**
  2. A certified safety representative must direct the required safety and health program and must be on-site while employees are engaged in operations during which the TSOs apply. The safety representative must have knowledge in underground safety, must be able to recognize hazards, and must have the authority to correct unsafe conditions and procedures subject to the TSOs. **8406(f)**
- D. Diesel engines: Diesel engines are the only type of internal combustion engine acceptable for use during tunneling operations, provided that the following requirements are met:
1. Cal/OSHA must issue a permit for diesel engine operation.
  2. Conditions of the permit must be observed.
  3. Ventilation and fresh air flow must meet the required minimum standards.
  4. Air concentrations of nitrogen dioxide, carbon monoxide, and carbon dioxide in the tunnel must be determined at least once during each shift at the peak of diesel operation and kept at or below the PELs.
  5. A written record must be kept of the above readings.
  6. PELs of the above air contaminants or any other contaminants must not be exceeded.
  7. A certified gas tester must conduct the testing (see additional requirements in **8470**).
  8. An approved exhaust purifier must be installed and maintained (see the requirements in **8470**).

- E. Materials, tools, and supplies being raised or lowered with a crane or hoist shall be secured or stacked to prevent the load from shifting, snagging, or falling, as required in **8500**.
- F. Licensed blasters: All blasting at tunnel sites shall be carried out or directly supervised onsite by a California licensed blaster as required by TSO **8560**.

## Welding, Cutting, and Other Hot Work

Each year, numerous deaths from explosions, electrocutions, asphyxiation, falls, and crushing injuries are associated with hot work activities. These deaths from hot work often occur in confined or restricted spaces. In addition, numerous health hazards, including heavy metal poisoning, lung cancer, metal fume fever, flash burns, and welders flash (burn to the eyes) are associated with exposure to fumes, gases, and ionizing and non-ionizing radiation formed or released during welding, cutting, brazing, and other hot work.

- A. Before workers begin hot work, the following controls must be established:
  - 1. No welding is permitted in an explosive environment. **4848**
  - 2. A written “hot work” permit is recommended whenever a combustible environment may exist. **4848**
  - 3. All combustible materials in the work area must be removed or shielded. **4848**
  - 4. Suitable fire extinguishers that meet NFPA and ANSI Standards must be provided in the work area. **4848**
  - 5. Welding blankets, curtains, and pads shall be approved for their intended use in accordance with section **3206.4848(b)**
  - 6. Employers must instruct employees on hot work safety. **4848(a)**
  - 7. Welders must be required to wear:
    - a. Non-flammable gloves with gauntlets. **3384**
    - b. Appropriate foot protection. **3385**
    - c. Aprons (leather) and shirts that have sleeves and collars. **1522(a)**
    - d. Helmets, hoods, and face shields suitable for head protection. **3381(a), 3382(a)**
    - e. Suitable eye protection. **3382**
    - f. Respiratory protection (as required). **5144**
    - g. Screens must be provided to protect the eyes of non-welders from flash burns and ultraviolet light rays. **3382(b)**
- B. Gas welding is regulated as follows:
  - 1. Fuel gas and oxygen hoses must be distinguished from each other. **1742(a)**
  - 2. Couplings must not disconnect by means of a straight-pull motion. **1742(g)**
  - 3. Oil or grease must never come into contact with oxygen equipment. **1743(c)**
  - 4. Oxygen from a system without a pressure regulation device must never be used. **1743(e)**
  - 5. Gas cylinders must be stored and used as follows:
    - a. Cylinders must be protected from all heat sources. **1740(a)**
    - b. Cylinders containing oxygen, acetylene, or fuel gases shall not be taken into confined spaces. **1740(b)**
    - c. Acetylene and fuel gas cylinders, including but not limited to welding and cutting fuel gas cylinders, shall be stored and used with the valve end up. **1740(b)**  
*Exception: Fuel gas cylinders containing fuel gas used to power industrial trucks regulated by Article 25 of the GISO.*
    - d. All gas cylinders in service shall be securely held in substantial fixed or portable racks, or placed so they will not fall or be knocked over. **1740(c)**
    - e. Cylinders must be handled in suitable cradles with their valve caps installed; they must never be lifted by magnet, rope, or chain. **1740(c), (d)**
    - f. Cylinders must not be placed where they might form a part of any electric circuit. **1740(e)**
    - g. Oxygen cylinders in storage shall be separated from fuel gas cylinders or combustible materials (especially oil or grease), a minimum distance of 20 ft. or by a

noncombustible barrier at least 5 ft. high having a fire-resistance rating of at least one-half hour. **1740(g)**

- h. Valve stem wrenches must be left in place while cylinders are in use. **1743(g)**
  - i. A fire extinguisher rated at least 10 B:C must be kept near the operation. **1743(j)**
  - j. Backflow protection is required. **4845(b)**
- C. Arc welding is regulated as follows:
- 1. Cables in poor condition must not be used; no cable may be spliced within 10 ft. of the electrode holder. **4851(e)(2)**
  - 2. The frames of arc welding and cutting machines must be grounded. **4851(f)(5)**
  - 3. Electrodes and holders that are not in use shall be protected so they cannot make electrical contact with employees or conducting objects. **4851(g)**
  - 4. Defective equipment must not be used. **4851(j)**
- D. Ventilation regulations for welding, cutting, and brazing operations require that workers' exposures to hazardous fumes, gases, and vapors be reduced below PELs. **1536, 1537, 5155**
- 1. Outdoor operations  
Respirators are required for any operation involving beryllium, cadmium, lead, or mercury. For other operations and materials, respirators are not required when natural or mechanical ventilation is sufficient to prevent exposure to airborne contaminants in excess of the PELs noted in **5155, 1536(c)**.
  - 2. Indoor operations  
Respirators shall be used when local exhaust or mechanical ventilation is not feasible or able to prevent exposures that exceed limits specified in **5155**.
- E. In enclosed spaces supplied-air respirators shall be used when local exhaust ventilation is not an effective means for preventing potentially hazardous exposures. **1536(b), 5152**
- F. Employer needs to include all potentially hazardous materials involved in welding and cutting such as fluxes, coatings, coverings, and filler metals in the HAZCOM program. Employer also must provide employee access to labels and safety data sheets, and train employees, as per **5194, 5150**.

## Wildfire Smoke

Smoke from wildfires contains chemicals, gases and fine particles that can harm health. The greatest hazard comes from breathing fine particles in the air (PM2.5), which can reduce lung function; worsen asthma and other existing heart and lung conditions; and cause coughing, wheezing and difficulty breathing. When the current Air Quality Index (AQI) for PM2.5 is 151 or higher, and workers may be exposed to wildfire smoke, employers are required to protect their workers.

- A. Determine if the air is harmful, using one of the following two methods: **5141.1(c)**
  - 1. Check AQI forecasts and the current AQI on a website specified in **5141.1(c)**, or subscribe to emails or texts.
  - 2. Use a direct reading instrument in accordance with **Appendix A of 5141.1** to check the current AQI at the start of each shift and periodically throughout the day.
- B. Protect workers if the current AQI for PM2.5 is 151 or higher outside:
  - 1. Communicate: **5141.1(d)**
    - a. Inform workers about the current AQI and the measures the employer is taking to protect them.
    - b. Encourage workers to inform the employer of worsening air quality and any symptoms that might be caused by exposure to wildfire smoke.
  - 2. Train and instruct workers on the items contained in **Appendix B of 5141.1**, at a minimum:
    - a. Health effects of wildfire smoke.
    - b. The right to obtain medical attention without fear of retaliation.
    - c. How to find out the AQI for PM2.5.
    - d. The requirements of title 8 section 5141.1.
    - e. The employer's two-way communication system.
    - f. The employer's methods to protect workers from wildfire smoke.
    - g. The importance, limitations, and benefits of using a respirator when exposed to wildfire smoke.
    - h. How to properly put on and use the respirators



provided by the employer.

3. Control worker exposures to wildfire smoke so that exposure to PM<sub>2.5</sub> is below an AQI of 151:
  - a. Use engineering controls, such as providing enclosed buildings, structures, or vehicles where the air is filtered. **5141.1(f)(1)**
  - b. If engineering controls are not enough, use administrative controls, such as moving the work to a location with less exposure to wildfire smoke, changing the work schedule, or taking more breaks. **5141.1(f)(2)**
  - c. Provide respirators, such as N95: **5141.1(f)(3)**
    - If AQI is from 151 to 500, provide respirators for voluntary use.
    - If AQI is above 500, provide respirators and require their use.

3. Lifesaving boats.

- B. Ramps used by vehicles to access the barges shall be strong, have side boards, be maintained, and be secured. **1603(a)**
- C. When employees can't step safely from a wharf, float, barge, or riverboat tow, a ramp compliant with **1603(a)** or a safe walkway needs to be provided. **1603(b)**
- D. All means of access to wharves, floats, barges, and boats shall be adequately illuminated for their full length. **1603(g)**
- E. Decks and other working surfaces of barges shall be maintained in a safe condition, as per **1511**, and **1603.1**.

## Wood Preservative Chemicals

Wood preservatives that contain creosote, pentachlorophenol, inorganic arsenic, and chromates are widely used. Because these chemicals are carcinogens, exposures to employees must be eliminated or reduced to the lowest levels possible below the PELs by using effective engineering controls (for example, enclosure or confinement of the operation, general and local exhaust ventilation, and substitution of less toxic materials). When effective engineering controls are not feasible, or while they are being instituted, use of NIOSH-approved respirators is required to eliminate harmful airborne exposures to these chemicals. **5141**, **5144(a)**, and **5214**

When the probability of skin or eye irritation exists, workers must use appropriate protective clothing and equipment, such as coveralls, gloves, shoes, face shields, or impervious clothing.

## Work Over or Near Water

- A. At locations where there is danger of drowning, employees shall use the following safety devices unless protected by appropriate fall protection measures: **1602(a)**
  1. Personal Flotation Devices (PFD).
  2. Ring buoys.

## List of Acronyms

**AB 1127:** Assembly Bill 1127

**ACCM:** asbestos-containing construction material

**ACGIH:** American Conference of Industrial Hygienists

**ACM:** asbestos-containing material

**AEGC program:** assured equipment grounding conductor program

**ANSI:** American National Standards Institute

**AQI:** Air Quality Index

**ASSE:** American Society of Safety Engineers

**ASTM:** American Society for Testing and Materials

**ATSSA:** American Traffic Safety Services Association

**°C:** Degree Celsius temperature scale

**Cal/OSHA:** California Occupational Safety and Health Administration

**Ca PE:** California Registered Professional Engineer

**CARB:** California Air Resources Board

**CASOs:** Compressed Air Safety Orders

**CAZ:** controlled access zone

**CCR:** California Code of Regulations

**CFR:** Code of Federal Regulations

**CO<sub>2</sub>:** carbon dioxide

**CSHIP:** Construction Safety and Health Inspection Project

**CSOs:** Construction Safety Orders

**cu. ft.:** cubic feet

**cu. yd.:** cubic yard

**d:** Penny size of nails

**dba:** a unit of sound level as measured on the A-scale of a standard sound level meter

**DOSH:** Division of Occupational Safety and Health

**EMS:** emergency medical service

**ESOs:** Electrical Safety Orders

**eTool:** electronic educational products for safety and health

**°F:** Degree Fahrenheit temperature scale

**FP:** fall protection

**FPP:** fall protection plan

**ft.:** feet

**GFCI:** ground-fault circuit interrupter

**GHS:** Globally Harmonized System

**GISOs:** General Industry Safety Orders

**HAZCOM program:** hazard communication program

**HEPA:** high-efficiency particulate air

**HP:** hearing protection

**IDLH:** immediately dangerous to life or health

**IIPP:** Injury and Illness Prevention Program

**in.:** inches

**ISEA:** International Safety Equipment Association

**LAZ:** limited access zone

**LEL:** lower explosive limit

**MSHA:** Mine Safety and Health Administration

**NFPA:** National Fire Protection Association

**NIOSH:** National Institute for Occupational Safety and Health

**NO<sub>x</sub>:** Oxides of Nitrogen

**o.c.:** on center

**OPU:** order to prohibit use

**PACM:** presumed asbestos-containing material

**PAT:** powder-actuated tool

**PEL:** permissible exposure limit

**PFA:** personal fall arrest

**PFP:** personal fall protection

**PFR:** personal fall restraint

**PM2.5:** particulate matter 2.5 micrometers or less in size

**PPE:** personal protective equipment

**psf:** pounds per square foot, unit of pressure

**psi:** pounds per square inch, unit of pressure

**QP:** qualified person

**RMI:** repetitive motion injury

**SAR:** supplied-air respirator

**SDS:** safety data sheet

**SO:** safety order

**sq. ft.:** square feet

**T8 CCR:** Title 8 of the California Code of Regulations

**tsf:** tons per square foot

**TSOs:** Tunnel Safety Orders

**TWA:** time-weighted average

**V:** volt, unit of electric voltage

## Index

*The subject headings are provided in all bold type fonts.*

### **About this Pocket Guide, 5**

Abrasives 18–19, 104–105, 137

### **Access, 6–7**

aerial devices, cranes, 6, 7  
elevators, 7  
ladders, 6, 7  
personnel hoist, 7  
ramps and runways, 7  
stairways, 6, 7

### **Administrative Requirements, 7–11**

certification, 7, 8, 11  
licensing, 11  
notification, 8, 9, 10  
permitting, 8, 9, 10, 11  
posting, 8–9  
recordkeeping, 8, 9  
registration, 8, 9, 11

### **Aerial Devices and Elevating Work Platform Equipment, 12–13**

aerial devices, 12–13  
elevating work platform, 12–13  
fall protection, 12

### **Airborne Contaminants and Dust, 13**

airborne contaminants, 13  
dust, 13

### **Air Compressors, 14**

permit, 14  
warning signs, 14  
portable air compressors, 14

Airless spray guns, 145

Annual permit, 10, 40

### **Asbestos, 8-11, 13, 14–19**

certification, 16  
monitoring, 15–17  
notification, 9, 15–16  
permissible exposure limit, 15–16  
registration, 15  
respiratory protection, 17  
training, 16, 18

Augers, 149  
Backup alarm, 92  
Band saws, 147  
Barricades, 41, 43, 52, 61, 72, 91, 94, 100, 133, 149  
Benching, 61–64  
**Blasting (Abrasives/Sand), 19**  
  respirator, 19  
  hearing protection, 19  
  body protection, 19  
**Blasting (Explosives), 19–20**  
  license, 19, 20  
  storage, 20  
  safety rules, 20  
  transportation, 19–20  
Boatswain’s chair, 69, 133  
Body protection, 19, 111  
Boom cranes, 31, 39  
Bracket scaffolds, 135  
Brakes, 12, 75, 76, 91, 92, 114  
  aerial devices, 12  
  forklifts, 75, 76  
  haulage vehicles, 92–93  
Cab (vehicle), 92  
Cadmium, 10, 13, 22, 156  
Cal/OSHA poster, 8, 50  
Canopy, 40, 75, 92  
  demolition, 40  
  forklift, 75  
  haulage equipment, 92  
**Carcinogens, 21**  
  reporting requirements, 21  
  SDS, 21  
Certification, 7, 8, 11, 16, 32, 39, 78, 96, 106, 153  
  administrative requirements, 7, 8  
  asbestos, 16  
  cranes, 11, 32, 39  
  falsework, 78  
  gas tester, 153

  IIPP, 96  
  lead, 106  
Chain saws, 143, 147–148  
Chutes, 40–41  
Circular saws, 143, 146, 147  
Clean-up, 16-18, 65, 81, 94, 103–104  
  Asbestos, 16–18  
  Explosion hazards, 65  
  Lead, 103–104  
**Code of Safe Practices, 21–22**  
  posting, 22  
  safety meetings, 22  
Combustible dusts, 65  
Combustible liquids, 73–74  
Combustible materials, 71, 154–155  
**Competent Person, 22**  
  asbestos, 22  
  bolting, riveting, 22  
  cadmium, 22  
  excavation, 22  
  fall protection, 22  
  lift-slab construction, 22  
  pressurized worksites, 22  
**Concrete Construction, 22–27**  
  concrete finishing, 27  
  finishing tools, 27  
  forms/falsework, 23  
  impalement hazards, 24–26  
  limited access zone, 23–24  
  masonry construction, 23–24  
  personal fall protection, 24  
  precast, 24  
  protective covers, 24–26  
  rebar, 22–24, 26–27  
  tilt-up panel, 24  
**Confined Spaces, 27–30**  
  atmospheric testing, 29  
  conditions, 27–28  
  definition, 27  
  entry/exit, 29  
  examples, 27–28  
  permit-required, 28–30

- written program, 29
- ventilation, 29

Construction elevators, 48–49

Controlled access zone, 8, 69

**Corrosive Liquids, 31**

- eyewash, 31
- HAZCOM program, 31
- personal protective equipment, 31
- SDS, 31

Covers (floor and roof openings), 52, 79–80, 121–122

**Cranes, 31–40**

- assembly/disassembly, 33–34
- certification, 31–32, 34, 39
- general requirements, 32–33
- inspection, 34
- operation, 35–36
- operational aids, 35
- operator qualification, 39
- power line safety, 33–34
- regulations, 31
- repairs, 34
- safety devices, 35
- side-boom cranes, 39
- signaling, 35, 36–39
- training, 32, 36, 39
- wire ropes, 34–35
- work area control, 36

**Demolition, 40–42**

- crane demolition work, 41–42
- hazards, 40–41
- permit, 40
- pre-demolition survey, 40
- techniques, 40–41

Derricks, 7, 11, 31–32–34, 35–36, 39

DOSH permit, 14, 40, 123

Drinking water, 85–90, 83, 84, 86, 142

**Dust, Fumes, Mists, Vapors, and Gases, 42–43**

- common sources, 42–43
- ventilation, 42
- respiratory protection, 42

Earth-moving equipment, 92–93

**Electrical, 43–48**

- arc, 44, 46
- general requirements, 43–45
- GFCI, 46
- grounding, 45, 46–48
- high voltage, 44–45, 47–48
- lock-out procedures, 48
- low voltage, 43–44
- minimum safe distances, 47
- protective equipment, 43, 44
- warning signs, 43, 48
- wiring methods, 45

Elevating work platform, 6, 12

**Elevators, Lifts, and Hoists, 48–49**

- capacity, 48
- inspection, 48, 49
- maintenance, 49
- requirements, 48

**Emergency Medical Services, 49–50**

- access, 49
- equipment, 50
- first aid, 49–50
- training, 49

Employee rights, 105

**Engine Exhaust Emissions, 50**

- exhaust devices, 50
- prohibition, 50

Engineering controls, 13, 42, 112, 106, 111–112, 158

**Erection and Construction, 51–54**

- erection plan, 51
- fall protection, 51, 52, 54
- floor openings/covers, 52
- flooring, 53
- structural steel, 51–53
- trusses and beams, 51
- wood frame, 53–54

**Ergonomics in Construction, 54–56**

- contributing factors, 55
- eliminating/reducing RMI, 56
- recovery time, 55
- requirements, 55–56
- RMI symptoms, 55

**Excavations, Trenching, Earthwork, 56–65**

- barriers, 61
- benching/shoring/sloping, 61–64
- competent person, 57–58
- inspection, 57
- notification, 56–57
- permit, 57
- protective systems, 57–61
- qualified person, 57
- requirements, 56–58, 61
- soil classification, 58–60
- Explosion Hazards, 65–66**
  - combustible dust, 65
  - flammable vapors, 65–66
  - LEL, 65–66
- Explosives, 19–20, 40
- Eye protection, 103, 121, 155
- Eyewash, 31
- Fall Protection, 66–71**
  - controlled access zone, 69, 70
  - fall distance, 68, 69
  - fall protection plan, 69, 70
  - guardrails, 66, 68, 71
  - lifeline, 67
  - personal fall arrest, 66–67
  - personal fall protection system, 66, 70
  - personal fall restraint, 66–67
  - qualified person, 67, 69
  - residential construction, 68
  - roof slopes, 68–71
  - safety monitoring system, 70
- Falsework, 11, 23, 54, 77–78, 80, 117
- Finishing tools, 27, 145
- Fire extinguishers 71–72, 121, 154, 156
- Fire Protection and Prevention, 71–72**
  - equipment, 71
  - extinguisher, 71–72
  - training, 72
  - water supply, 71
- First Aid, 72**
  - emergency medical services, 72
  - first aid kit, 72
  - trained personnel, 72
- Fit testing, 113
- Flaggers, 72–73**
  - apparel, 73
  - high-visibility apparel, 73
  - traffic control, 72–73
  - training, 73
  - warning signs, 72–73
- Flammable and Combustible Liquids, 73–74**
  - closed containers, 73
  - HAZCOM, 74
  - leakage, 73
  - storage, 74
  - transportation, 74
  - usage, 74
- Flexible cords, 45–46
- Float scaffolds, 69
- Foot protection, 111, 149, 154
- Forklifts, 74–76**
  - certification, 76
  - elevating employees, 74–75
  - lifting capacity, 74
  - operating rules, 75
  - posting, 74, 75
  - regulations, 74
  - training, 75–76
- Forms, Falsework, and Vertical Shoring, 77–78**
  - access, 78
  - design, 77–78
  - design loads, 77
  - erection, 77
  - fall protection, 78
  - inspection, 77–78
- Framing, 10, 54, 68
- Fumes, 13, 42–43, 50, 81, 154, 156
- Gas, 13, 27, 40, 42–43, 50, 65–66, 71, 81, 116, 120, 151, 152–153, 154–156, 157
- Gas cylinder, 121, 155
- Gas tester, 153
- Generator, 46
- GFCI, 46

Grounding, 45–47

Guarding, 24, 44, 81, 93, 110

### **Guardrails, 78–80**

- applications, 79–80
- elevator shaft openings, 80
- fall protection, 78, 80
- floor/roof openings, 79–80
- mid-rail, 78–79
- specifications, 78–79
- top rail, 78–79
- wall openings, 80

Guards, 44, 100, 143, 145–146

Hand protection, 111

Hand signals, 37–38

Harness, 65, 67–68, 132

Haulage and earth-moving equipment, 92–93

### **Hazard Communication Program (HAZCOM), 81–83**

- labeling, 81–83
- list of hazardous substances, 81
- training, 81–83
- program, 81–83
- SDS, 81–83
- safe handling, 81

Hazardous chemicals, 40, 81–83

Head protection, 65, 112, 155

Hearing protection, 19, 112, 149

### **Heat Illness Prevention, 83–90**

- emergency response, 85, 88–89
- fainting, 83, 84
- heat cramps, 83, 84
- heat exhaustion, 83, 84, 90
- heat rash, 83, 84
- heat stress, 90
- heat stroke, 83, 84–85, 90
- high-heat procedure, 85, 87–88
- shade, 85, 86–87, 89
- symptoms, 83–85
- training, 83, 87, 89–90
- water, 85–90
- written procedures, 85

### **Heavy Construction Equipment, 90–93**

- flaggers, 91
- haulage and earth-moving equipment, 92–93
- safety requirements, 90–93
- seat belts, 91–92

High voltage, 8, 13, 23, 29, 33, 44–45, 47–48

Highlift trucks, 8

Hitches, 134–135

Hoists, 7, 48–49

Horn, 35, 75

Horse scaffold, 126, 136

### **Hot Pipes and Hot Surfaces, 93**

Hot work, 154

### **Housekeeping/Site Cleaning, 94**

- ground areas, 94
- storage areas, 94
- work surfaces, 94

Impalement, 22, 24–26, 54, 68, 120

Industrial trucks, 6, 8, 74–76, 93, 155

### **Injury and Illness Prevention (IIP) Program, 94–96**

- code of safe practices, 95
- elements, 94–95
- employee rights, 96
- general safety requirements, 95
- recordkeeping, 95
- requirement for construction, 95
- safety training, 95–96
- written program, 95–96

Insulated tools, 46, 113, 142, 143

Jackhammer, 144, 149

Knots, 94, 135

### **Ladders, 96–102**

- ladder size, 98
- ladder types, 97–98
- portable ladders, 97–99, 101
- training, 101–102

Ladder jack scaffold, 136

**Laser Equipment, 102–103**

qualified person, 102  
warning signs, 103

**Lead, 103–106**

blood lead monitoring, 105  
certification, 106  
monitoring, 106  
permissible exposure limit, 104  
personal protection, 104  
pre-job notification, 106  
protective requirements, 105  
training, 104, 105, 106  
trigger tasks, 104–105  
warning signs, 105

Licensed blaster, 11, 19, 20, 154

Lifts, 6, 12, 40–41

**Lighting, 106–107**

minimum illumination, 107  
night-time lighting, 107

Limited access zone, 23

Load weighing device, 35

**Lock-out/Block-out Procedures, 107–110**

blocking, 108, 109  
energy control procedure, 108–109  
extension tools, 108  
notifying, 109  
tagging, 108–109  
training, 107–108

Low voltage, 43–44

**Machine Guarding, 110**

Masonry, 13, 23–24, 144

Mists, 42, 43, 81

**Multi-Employer Worksites, 110–111**

controlling employer, 111  
correcting employer, 111  
exposing employer, 110  
creating employer, 110–111

Multi-unit roofs, 117–118, 119

Needle-beam scaffolds, 69, 133–134

Non-sparking tools, 20

Overcurrent protection, 45

Overhead lines, 23, 31, 33, 45, 47

Oxygen breathing gas system, 116

Oxygen deficiency, 27, 42, 56, 64

Paint, 15, 42, 51, 73, 81, 97, 99, 103–104, 128

Permissible exposure limit, 13, 15, 16, 17, 103, 104, 105, 106, 137, 153, 156, 158

Permit, 7, 8, 9, 10–11, 14, 19, 22, 27–30, 40, 48, 51, 57, 86, 123, 153, 154

**Personal Protective Equipment, 111–113**

body protection, 111–112  
eye protection, 111  
hand/foot protection, 111  
head protection, 112  
hearing protection, 112  
respiratory protection, 112–113

**Pile Driving, 113–115**

fall protection, 114  
hammer/hammer stop block, 113–114

Planking, 52, 80, 125–126

Platform, 6, 12–13, 53, 68, 70, 74–75, 79, 100, 107, 113–114, 118–120, 122–136, 141  
forklift, 6, 74–75  
roofing, 118–120  
scaffold, 79, 122–136, 141

Pneumatic nailer, 69, 148

Pneumatic tool, 148

Posting, 7–8, 21, 22, 28, 41, 48, 50, 70, 74, 75, 78, 93, 95, 103, 105, 127

Powder-actuated tool, 9, 144–145

Power-operated tools, 142–143

Precast, 10, 24

Pre-job safety conference, 152

**Pressurized Worksites, 115–116**

decompression, 115–116  
notification, 115



- regulatory requirements, 115–116
- supervising physician, 116
- ventilation, 116

### **Qualified Person, 116–117**

- Railings, 12, 24, 41, 49, 52, 53, 54, 61, 66, 68, 71, 74, 75, 78–80, 117, 118–121, 125, 127, 129, 131, 132, 136, 139, 140–141

### **Ramps and Runways, 117**

- foot ramps, 117
- wheelbarrow ramps, 117

### **Rebar, 24–27**

- fall protection, 24
- impalement protection, 24–26
- supporting of rebar, 27

### **Recordkeeping, 9, 95, 138**

### **Registration, 7, 8, 9, 11, 15, 96**

### **Repetitive motion injury, 55–56**

### **Reporting, 9, 19, 21, 56, 87–88, 96**

- accidents, 9
- blasting, 9, 19
- carcinogens, 10, 21
- heat illness, 87–88
- IIPP, 96
- RMIs, 56

### **Respiratory protection, 8, 13, 17, 19, 42, 93, 104–105, 112–113,**

**121, 137–138, 155–156, 157–158**

- asbestos, 17, 42
- dust, 19, 42
- lead, 104–105
- program, 8, 17, 113
- silica, 138
- welding, 42, 105, 155–156
- wildfire smoke, 157–158

### **Rollover protection, 75, 91**

### **Roofing Operations, 117–122**

- fall protection requirements, 118, 119, 120, 121–122
- hot operations, 120–121
- multi-unit roof, 118, 119
- new-production type, 118, 120
- roof openings, 121
- single-unit roof, 117, 118–119

### **Safety apparel, 73, 91, 149**

### **Safety conference/meeting, 11, 22, 95, 151–152**

### **Safety factor, 67**

### **Safety harness, 132**

### **Safety monitoring system, 70**

### **Safety nets, 66, 68**

### **Safety precautions, 22, 95**

### **Safety programs, 5–6, 11, 95**

### **Safety training, 73, 76, 95–96, 101–102, 139–140, 150–151**

### **Safety valve, 14**

### **Sanitation, 116, 141**

### **Saws, 18, 143, 145–148**

- band saw, 147
- chain saw, 143, 147–148
- circular saw, 143, 146, 147
- guard, 143, 145–147
- miter saw, 146
- radial arm saw, 146–147
- speed, 146, 147, 148
- table saw, 147

### **Scaffolds, 122–136**

- access, 123–124, 131
- design and construction, 122–123
- erecting and dismantling, 123
- general requirements, 122–128
- guardrails/railing, 127, 129
- height limits, 127
- horse scaffold, 126, 127, 136
- ladder jack scaffold, 136
- planking, 122, 124–126, 130, 132, 134
- platforms, 124–125, 128, 131
- prohibited scaffolds, 127
- prohibited work practices, 127–128
- self-propelled rolling scaffolds, 129–130
- suspended scaffold, 131–136
- tower and rolling scaffolds, 128–131
- tube and coupler, 128, 133
- window jack scaffolds, 136
- working load, 122, 126, 127

### **SDS, 21, 31, 81–83**

### **Seat belts, 75, 91**

Serious injury or illness, 9, 19

Shafts, 50, 61, 64–65, 67, 68, 80, 140, 152

Shoring, 11, 22, 23, 54, 61, 77, 139

**Silica Dust, 137–138**

- hazardous work activities, 137
- control, 137–138
- PELs, 137
- silica-containing materials, 137
- training, 138

Slings, 7, 35, 76

Sloping, 61–64

Soil classification, 58–61

**Stairways, 138–139**

- illumination, 139
- railings, 139
- width, 139

Structural steel, 10, 51

Supplied-air respirators, 17, 19, 104–105, 156

Tailgate/toolbox safety meetings, 22, 95, 151

Tar/asphalt, 117–118, 121

**Temporary Agencies, 139–140**

- injury/illness records, 140
- responsibility, 139–140
- training, 139–140

Thermal insulating material, 93

**Toeboards, 140–141**

- clearance, 141

**Toilets/Washing Facilities/Sanitation, 141–142**

- drinking fountain, 142
- toilet facility, 141–142
- washing station, 141–142
- shower, 142

**Tools and Equipment, 142–149**

- airless spray gun, 145
- band saw, 147
- chain saw 143, 147–148
- circular saw, 143, 146, 147
- concrete-finishing tool, 145
- control switch, 143–144

guard, 143, 145–147

miter saw, 146

pipe threading machine, 149

powder-actuated tool, 144–145

power-operated tool, 142–143

pneumatic tools, 148–149

radial arm saw, 146–147

table saw, 147

**Traffic Control, 149–150**

employees on foot, 149

flagger, 149

high-visibility apparel, 149–150

**Training, 150–151**

effective training, 150

tailgate/toolbox meeting, 151

training requirements, 150–151

Trenching, 11, 50, 56–65

**Tunnels and Tunneling, 151–154**

certified persons, 153

classification of gas hazard, 152

diesel engine, 153–154

licensed blaster, 154

pre-job safety conference, 152–153

safety representative, 153

ventilation, 153

Vapors, 13, 42–43, 65–66, 81, 156

Ventilation, 18, 29, 42, 50, 65–66, 74, 116, 121, 153, 156

Vertical shoring, 11, 23, 54, 77, 139

Warning device, 92

Warning signs, 8–9, 14, 18, 43, 48, 72–73, 78, 82, 91, 103, 105, 145, 149

Water - drinking, 85–86, 87, 142

**Welding, Cutting and Other Hot Work, 154–156**

arc welding, 156

gas cylinder, 155–156

gas welding, 155–156

hot work permit, 154

respiratory protection, 155, 156

ventilation/exhaust, 156

Wells, 61, 64–65

**Wildfire Smoke, 157–158**

exposure controls, 158  
 respirators, 157, 158  
 training, 157–158

Window jack scaffold, 136

Wiring method, 45–46

**Wood Preservative Chemicals, 158**

Work surfaces, 22, 24, 40, 66, 78, 79, 94, 127, 132, 148

Working load, 12, 97, 98, 102, 122–123, 126, 127

**Work Over or Near Water, 158–159****Workplace Safety and Health, 5–6**

Wrecking ball, 42

## Division of Occupational Safety and Health (DOSH) Headquarters

1515 Clay Street, Suite 1901, Oakland, CA 94612

Phone (510) 286-7000

Internet [www.dir.ca.gov/dosh](http://www.dir.ca.gov/dosh)

**CAL/OSHA ENFORCEMENT**

To report workplace accidents and file complaints, contact the nearest Cal/OSHA Enforcement Office listed below:

**Regional Offices**

**San Francisco**  
(415) 557-0300

**Sacramento**  
(916) 263-2803

**Santa Ana**  
(714) 558-4300

**High Hazard Unit**  
**Santa Ana:** (714) 567-7100  
**Oakland:** (510) 622-3009

**Monrovia**  
(626) 471-9122

**District Offices**

**American Canyon**  
(707) 649-3700

**Bakersfield**  
(661) 588-6400

**Foster City**  
(650) 573-3812

**Fremont**  
(510) 794-2521

**Fresno**  
(559) 445-5302

**Long Beach**  
(424) 450-2630

**Los Angeles**  
(213) 576-7451

**Modesto**  
(209) 545-7310

**Monrovia**  
(626) 239-0369

**Oakland**  
(510) 622-2916

**Redding**  
(530) 224-4743

**Sacramento**  
(916) 263-2800

**San Bernardino**  
(909) 383-4321

**San Diego**  
(619) 767-2280

**San Francisco**  
(415) 557-0100

**Santa Ana**  
(714) 558-4451

**Van Nuys**  
(818) 901-5403

# Cal/OSHA Consultation Services Branch

**TOLL-FREE** 1-800-963-9424

**INTERNET** [www.dir.ca.gov/dosh/consultation.html](http://www.dir.ca.gov/dosh/consultation.html)

**E-MAIL** [InfoCons@dir.ca.gov](mailto:InfoCons@dir.ca.gov)

## On-Site Assistance Program Area Offices



- 1 Sacramento**  
*Northern California*  
(916) 263-0704
- 2 Oakland**  
*San Francisco/Bay Area*  
(510) 622-2891
- 3 Fresno**  
*Central Valley*  
(559) 445-6800
- 4 Van Nuys**  
*San Fernando Valley*  
(818) 901-5754
- 5 La Palma**  
*La Palma, Los Angeles Metro Area, Orange County*  
(714) 562-5525
- 6 San Bernardino**  
*San Bernardino, Inyo and Riverside Counties*  
(909) 383-4567
- 7 San Diego**  
*Imperial and San Diego Counties*  
(619) 767-2060



**California Voluntary  
Protection Program  
Oakland:**  
(510) 622-1081

### Worker Information Hotline

For telephone numbers and website addresses to help workers with safety and health and other workplace concerns call DIR's Toll-Free Number: 1-866-924-9757

Updated July 2022